

# ORYONE UN1 note validator (ARM3) ORYONE UN1 M.S. note validator (ARM3)

Operator's Manual

Rev. 1.06



## Operator's Manual



Via Cà Bianca, 421 - 40024  
Castel San Pietro Terme (BO) - Italy

Progettazione e produzione di sistemi di pagamento e accessori per macchine Gaming, Vending e Car-Wash

Tel.: +39.051.944300  
Fax.: +39.051.944594

Web: [www.alberici.net](http://www.alberici.net)  
E.mail: [info@alberici.net](mailto:info@alberici.net)



## **NOTICE**

Every possible care has been taken in the preparation of this manual.

Nevertheless, there is no guarantee at all times about the absolute correspondence of the descriptions contained in this manual with the characteristics of the product. The Alberici S.p.A. disclaims any responsibility towards the User with respect to damages, losses, or claims of third parties, arising from use of the product or caused by misinterpretation of this manual.

Alberici S.p.A. reserve the right to change, without notice, in any way any portion of this manual.

# CONTENTS

1.	General .....	4
2.	Package contents .....	5
3.	Product description.....	5
4.	Mounting instructions .....	7
5.	Messages.....	16
6.	Maintenance.....	17
7.	Calibration.....	18
8.	Disposal of the Product.....	20
9.	Terms of Guarantee.....	20
10.	Customer Service.....	20

STORICO REVISIONI			
Revisione n°	Data	Modifica	Note
Creazione	14.06.17		
v.1.01	03.11.17	MDB su ARM 3	
v.1.02	18.12.17	Configurazione parallela in modalità PULSE / Nuova IF ccTalk	
v.1.03	14.05.18	Procedura calibrazione	
v.1.04	11.03.19	Aggiornamento mini-USB	
v.1.05	24.07.19	Versione con sensore magnetico	
v.1.06	11.04.22	Nuove introduzioni rosse	standard 72mm EURO, 83mm UNIVERSAL, 67mm USD, 60-75mm PLN

# 1. General

- We would like to thank you and congratulate for your choice. The **OryOne UN 1** is the natural evolution of the previous model. It has been deeply improved by the following features, that extend and enhance its performances.

Feature	Benefits
<ul style="list-style-type: none"><li>- ARM Microprocessor</li><li>- Processing memory for parameters has been doubled</li><li>- Protocols MDB/CCT/PULSE/SAS; on-board USBport</li><li>- New class of fulltransparencyreflectingprisms</li><li>- 4-layer electronic board</li><li>- Twodiscriminationratescommutedbydip-switch</li><li>- Dip-SwitchTableendowedwithnewfunctions</li></ul>	<ul style="list-style-type: none"><li>- Allows for top performance in terms of security, precision, and low power consumption.</li><li>- More discriminating criteria available.</li><li>- Quick build-in for all major market applications; easy Dip-Switch swap between protocols.</li><li>- More efficient Anti-Fraud system.</li><li>- Neutralizes magnetic interferences and electrostatic charges, assuring stability and precision in operation</li><li>- ACCEPTANCE RATE 93%: HIGH SECURITY AGAINST FAKES, <i>or else</i> !!! ACCEPTANCE RATE 98%: STANDARD SECURITY RATE !!! <b>BEWARE: IT IS RECOMMENDED TO SWITCH DS6 TO ON POSITION</b></li><li>- Easy and flexible manual re-programming</li></ul>

## 1.1 Host machine design

- The manufacturer takes all possible measures to ensure the quality of the product. However, performance decay or circuit faults could occur through the product's life. Please ensure safety operation by making use of fail-safe design.
- Please allow enough space around the validator to allow easy removal of the unit or collection of the banknotes.

## 1.2 Mounting

- Do not obstruct the acceptor's air intakes or else proper cooling will not be possible
- Do not use the acceptor in extreme or widely changing temperature
- Do not expose the acceptor to direct sunlight or to incandescent lighting (> 3000 Lux)
- Do not use or store the acceptor in dusty areas or in presence of chemical vapours or sprays
- The acceptor is for indoor use only. Do not use it outside.
- When using the acceptor in presence of car exhausts or smoke, please clean and maintain the acceptor frequently.

## 1.3 Wiring

- Switch power supply off before connecting or disconnecting any cables.
- When wiring the connection cable, pay utmost attention to the specified power range and pin assignment. Wrong wiring may cause unit damage.
- Connect the power cable firmly.
- Do not pull or stretch the power cable.

## 1.4 Caution

- When opening the Upper/Lower lid, disconnect power to the acceptor.
- When closing the Upper lid, do not put your fingers through.
- Do not modify the unit. Doing so may damage the product.
- Do not bump or drop the acceptor.
- Do not wipe or clean with thinners or organic solvents.
- Do not let moisture or liquids into or onto the acceptor.
- Do not use the acceptor outside the temperature / humidity range.
- Banknotes might not be properly accepted, or might jam or damage the unit, if:
  - they are stained, worn, moistured, dog-eared, oil-smearred, torn or wrinkled
  - their dimensions are incorrect, or wrongly printed
  - they bear foreign bodies (i.e. sticking tape, a.s.o.)

## 1.5 Disposal

- Dispose of this unit according to your Country's regulations for such types of industrial waste. This product is RoHS-compliant.

## 2. Package content

The package contains the following items:

1. ORYONE UN1 note validator
2. Installation manual (this manual), or the Quick Guide

This unit has been carefully packed, with special attention to protect it against damages. However, if you find anything damaged or missing, please contact immediately your local distributor. Upon reception, please open the box and check for eventual damages, deficiencies or abnormalities, and in such case immediately report it to the forwarder and on the collection receipt.

## 3. Product description

The labels in the picture show the data updated to the versions of FW and HW valid at 04.06.2019.

Model: ORYONE UN1  
 Protocols: ccTalk(non-encrypted)+USBport /  
 PulseParallel or Multi-Pulse / MDB  
 VersionHW: 3.00-01 (\*)  
 VersionFW: u2.3 A4.0.6(\*)  
 Mechanical Rev. RM: 5.3.0  
 Powersupply: +24V  
 Currentdraw: 0,4 A (max. 1.0A)  
 Currency: EURO

<b>Alberici</b>		<b>ORY ONE U</b>	
Pw:24Vdc	<b>ccTalk - Pulse</b>		
0.4A(max1A)	EU: 5 10 20 50 100		
Cid:236	PB:EU.2.0.0.5		
Rm:5.3.0	Hw:3.00-01	Fw:u2.3 A4.0.6	

**Patented**  
**RoHS** 3019



Default currency is EURO: 5.1-10.1-20.1-50.1-100.1 (series Eur I), 5.2-10.2-20.2-50.2-100.2 (series Eur II).  
 Please ask in advance for different needs (see Appendix 1 page 20 for the available datasets).

It is however always possible to re-program the validator for a different currency, by using the programming InterFace K-P1C-000009 (or the K-P2C-000003 IF) in combination with the "AlbericiUpgLetto" software.

Inlets available are:

### STANDARD VERSION:

- standard 72mm EURO red inlet (P-ALB026-002)
- 83mm UNIVERSAL red inlet (P-ALB025-002)
- 67mm USD red inlet (P-ALB025-002)
- 60-75mm PLN red inlet (P-ALB027-002)

### MAGNETIC SENSOR VERSION:

- 67mm USD red inlet (P-ALB025-002)
- 83mm UNIVERSAL red inlet (P-ALB025-002)

*These "MS" versions are meant to be used for CURRENCIES WITH MAGNETIC IDENTIFICATION ELEMENTS*

The serial number includes the product identifier 'LBO-', followed by the progressive production no. made up of 7 digits. Example: LBO-0084312.

The relevant data of the note validator can also be read by using the "AlbericiUpgLetto" Software:

(\*) to-date: 04.06.2019

<b>Alberici</b>		<b>ORY ONE UMS</b>	
Pw:24Vdc	<b>ccTalk - Pulse</b>		
0.4A(max1A)	EU: 5 10 20 50 100		
Cid:236	PB:EU.2.0.0.5		
Rm:5.3.0	Hw:3.00-01	Fw:u2.3 A4.0.6	

**Patented**  
**RoHS** 3019



### 3.1 Parts description

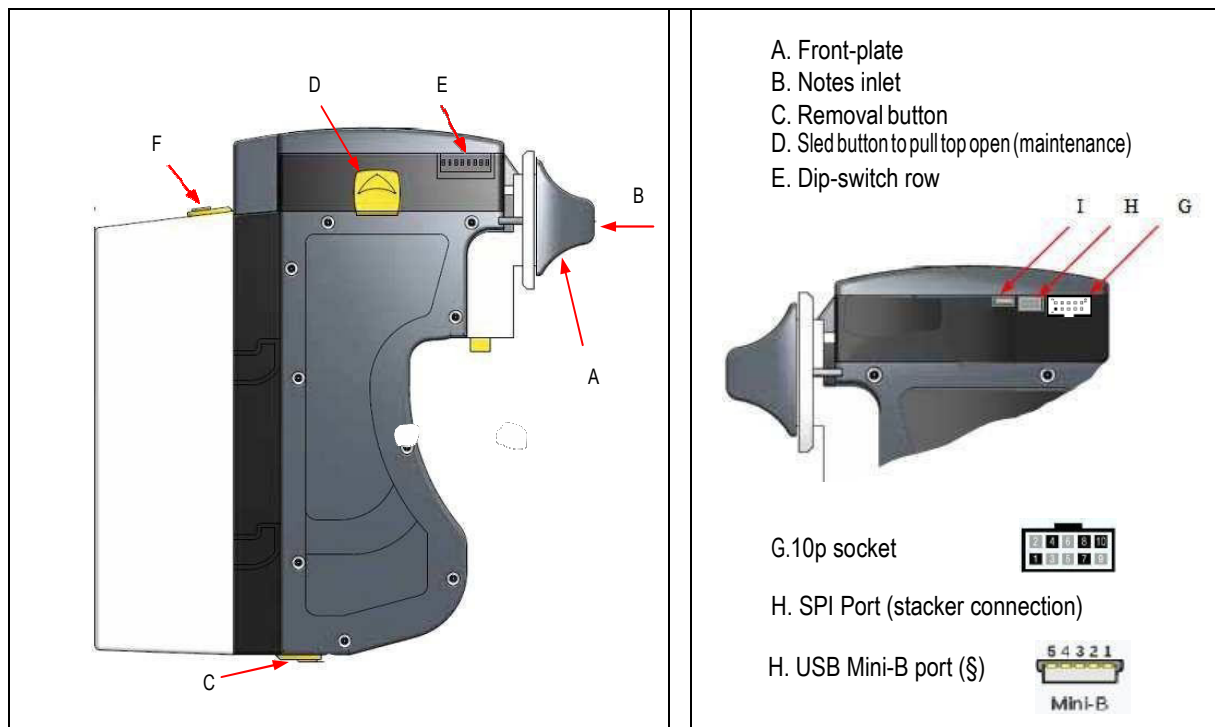

(§) The USB output is not available on the MDB version.

### 3.1 Technical Specifications

ALIMENTAZIONE / POWER SUPPLY	+24V, ±5%
ASSORBIMENTO / CURRENT DRAW	200 mA (stand-by)   400 mA (work cycle, max 1 Amp)
PROTOCOLLI / INTERFACE	ccTalk / Pulse + USB mini-B / MDB (§)
TASSO DI ACCETTAZIONE / ACCEPTANCE RATE	92% = alta sicurezza / high security setting 98% = sicurezza standard / standard security setting
TECNOLOGIE DI RICONOSCIMENTO / SCAN TECHNOLOGY	Trasparenza e riflessione (sensori IR e sensori cromatici) VHR VHR transparency and reflection (IR and colour sensors)
VELOCITÀ DI VALIDAZIONE / VALIDATION SPEED	2 sec ca. (4 versi) / approx. 2 sec (any of 4 directions)
BANCONOTE COMPATIBILI / BANKNOTE SIZE	72 – 83,0 mm larghezza / width - vers. \$ M.S. = 67 mm
TEMPERATURA DI UTILIZZO / OPERATING TEMPERATURE	0°C ÷ 50°C (senza condensa/without condensation)
TEMPERATURA DI MAGAZZINO / STORAGE TEMPERATURE	-10°C ÷ 60°C (senza condensa/without condensation)
PESO / WEIGHT	1,464 Kg
CAPACITÀ DELL'IMPILATORE / STACKER CAPACITY	300 or 600 banknotes

(§) The USB output is not available on the MDB version.

## 3.2 Dimensions



N.B.: All measures in mm

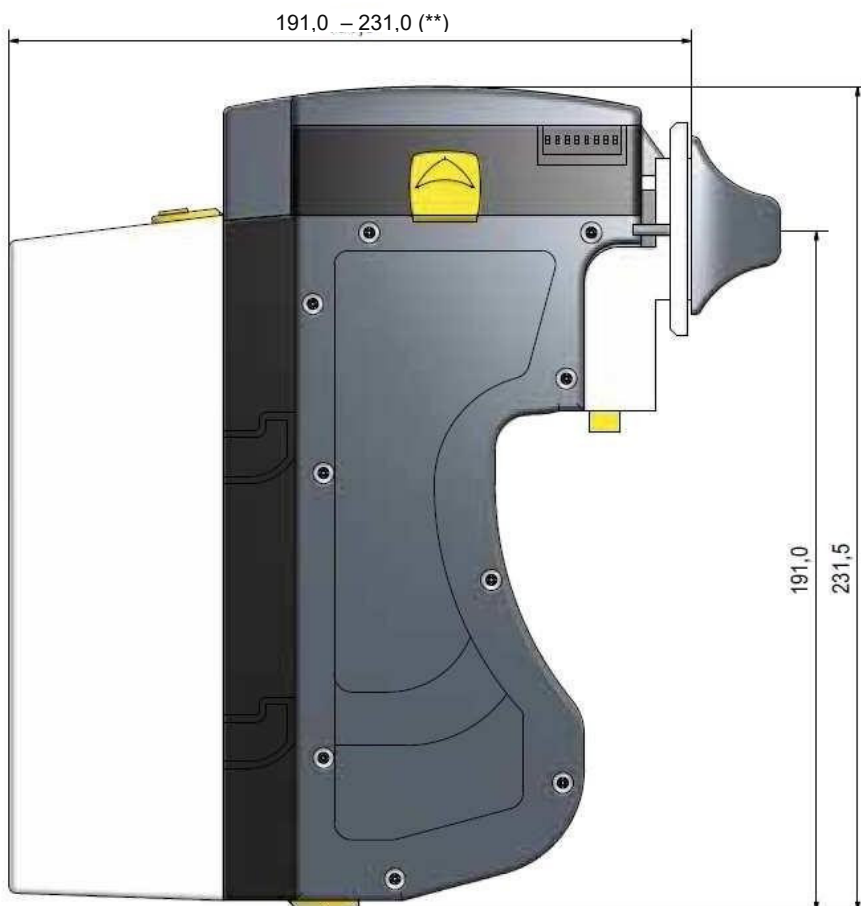

(\* ) OryOne UN1 - OryOne UN1 Univ. M.S = 72,0 mm  
 [ 75mm inlet or 83mm inlet can be requested as options ]  
 OryOne UN1 \$ M.S. = 67,0 mm

(\*\* ) Stacker 300 banknotes = 191,0 mm  
 Stacker 600 banknotes = 231,0 mm

## 4. Mounting instructions

### 4.1 General

Installation	Preferably indoors; always integrated into cabinets suited to the place of use.
Positioning	Mounting on plate (protected against vibrations and shocks). Allow at least 50 mm free space around to allow easy removal of the unit or collection of the banknotes. Please consider that size of 300-banknote stacker is different from size of 600-banknote stacker.
Light	Prevent direct sunlight from hitting the inlet: use incandescent lamps in the working environment. Gradient of incidence of the light: > / = 15 degrees.

## 4.2 Mechanical fitting

1. Mounting panel can be up to 7mm thick. Cutout a window as shown in figure below, size 21 mm (height) x 95 mm (width). Preset the four "A" studs (M4x20) on the mounting panel. Take care to preset also the 3 + 1 studs (M4x20 as well) for the lower fixing holes ("B").

Panel presetting for cut-out and upper 4 studs (M4x20)

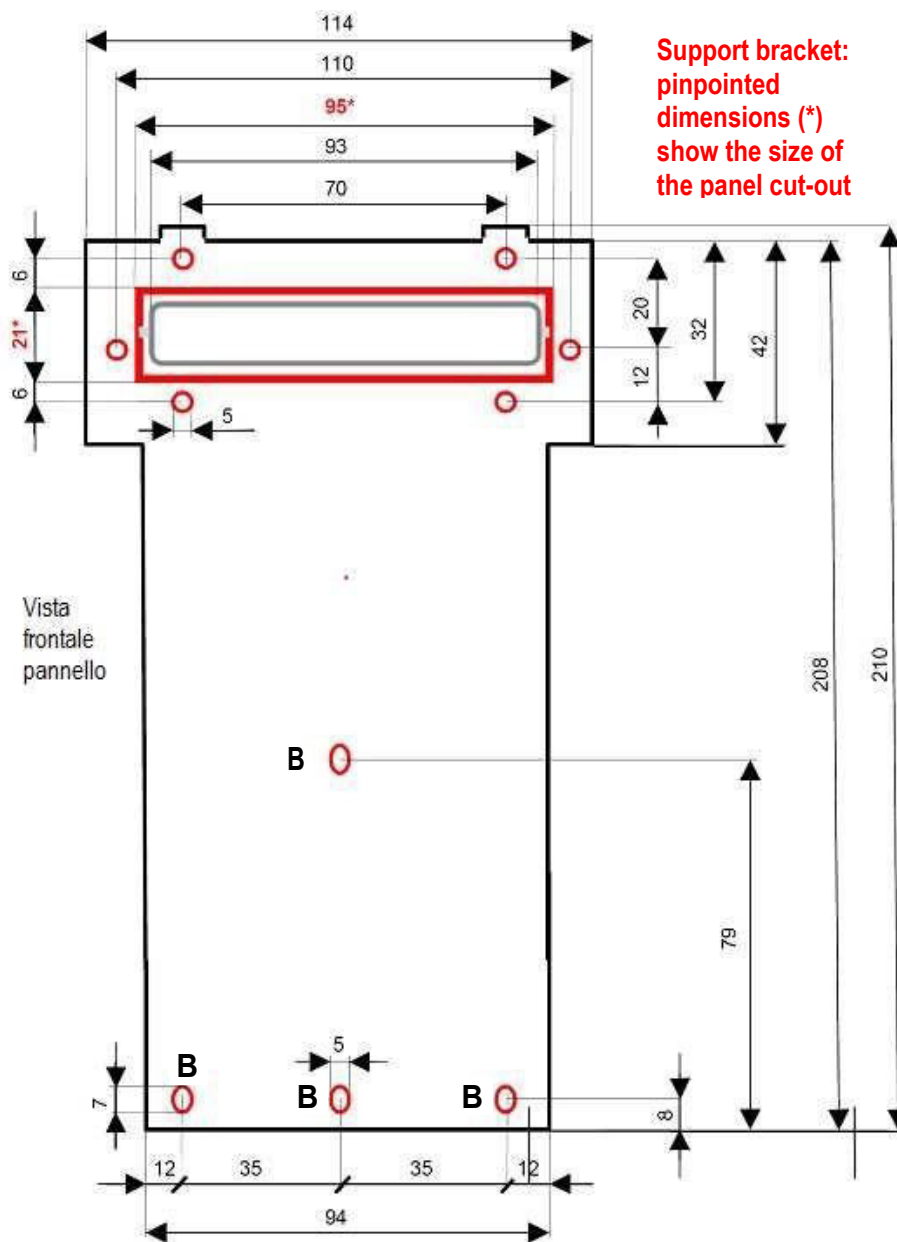
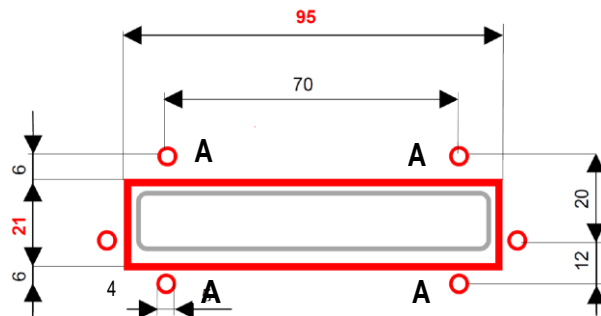



The chrome bezel cod. AA-0238 is available as option::

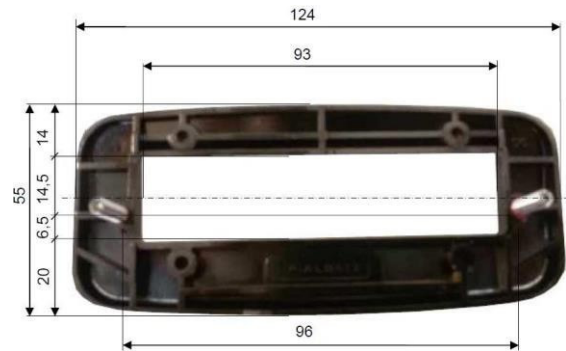

2. Press the yellow button "1" (located under the validator) to release the main body from the A-LB0063 support bracket (A-LB0062 for the US\$), and slide the validator body backward until it comes out.

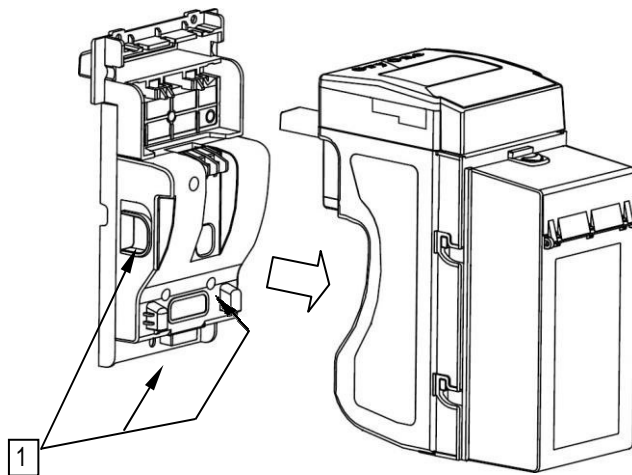

3. Fasten the support bracket to the mounting panel by 8 x M4 nuts. Take care not to tighten the nuts too much.
4. Insert the inlet of the note validator in the cut-out, and push the unit forward, until it hooks in. Make sure that the validator and its bezel are securely fixed to the door.
5. To remove the device from the door/mounting panel, just push upwards button "1".

NOTICE: Press push button 2 to remove the cash-box from the validator.  
To open up the cash-box and take banknotes out, slide backward button "3".

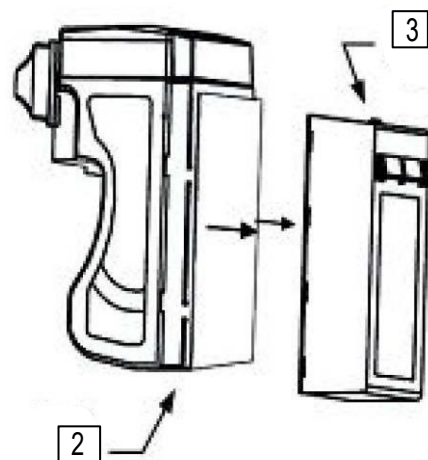

## OPENING THE HEAD UNIT

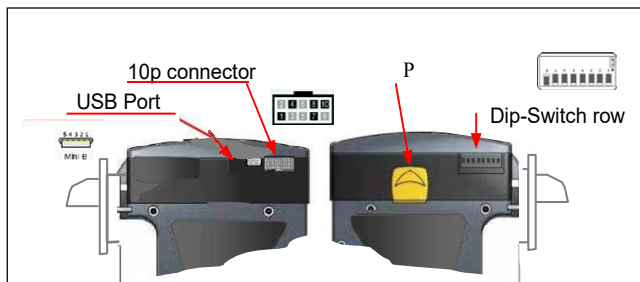

Press the yellow button (T) to remove the faceplate.

*Cleaning: press the slide-button (P) to open the upper cover.*

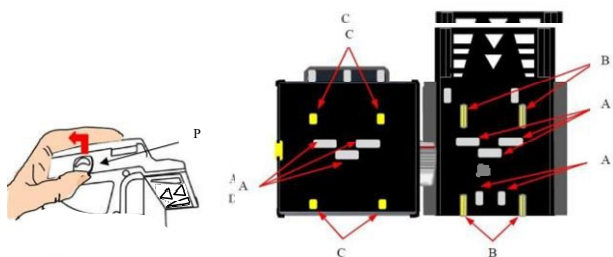

A. Optic sensors    B. Traction Rollers    C. Matching wheels  
D. Magnetic Sensor (only in LB-MU02, LB-LU11, LB-MU12)

*Cleaning: wipe the sensor surface off by a lint-free cloth or by a cotton-bud, eventually moistened with isopropyl alcohol to clean parts A, B and C.*

### 4.3 Electrical connections and settings of the unit

Power the ORYONE UN1 validator by 24 Vdc.

Once connected, take care that the cable is protected against any mechanical stress or accidental pull.



#### 4.3.1 Connection wiring

Make use of quality components complying with the current draw values, as for example:

Socket	IDC socket	Socket for flat cable
Wire	AWG24 (UL1061)	Flat cable, pitch 1,27 mm - AWG28 (UL2651/UL20012)

To connect the validator to the machine board:

1. Make sure the power is off.
2. Insert the cable into the 10p connector.
3. Turn on the power and test for correct operation.

Starting from Rm 5.2.0, the note validator is equipped with one **mini-USB port**, that can be used for **ccTalk direct communication (without echo message)** between the validator and the host.

Win10 includes the drivers, else please download them from the validator page in our website.

ccTalk communication only flows through the mini-USB port, while power (12/24Vdc for BillyOne, or 24Vdc for OryOne) must be provided to Pin 10 (+) and Pin 8 (GND) of the 10p socket.

The note reader must be set to **ccTalk protocol (Dip-Switch 1 = ON)**.

**Updating, programming, and calibration** still need the external grey USB interface (pendrive or kit) to be connected to the **10p socket**.

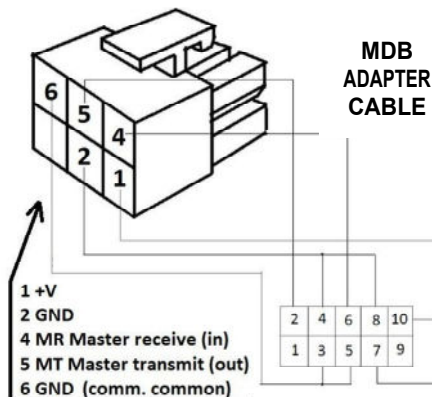
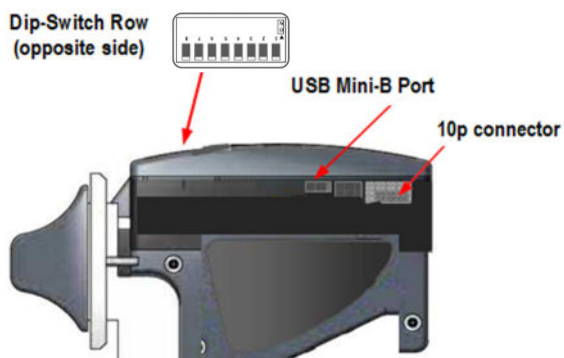

#### 4.3.2 MDB 10p pin-out to 6p plug

When setting the reader for MDB protocol (see 4.3.4 Dip-Switch Settings), the 10p outputs must be converted to the 6p MDB standard cable from the master pcb of the machine.

The MDB cable can be ordered by the #nr. S-031005-000.

### 4.3.3 10 Pin interface connector



The 10p connector, for connection to the machine Master board, is located at the right side of the BILLYONE UN1 note reader. Starting from hw 2.00 and fw u 2.1.A.3.0.6, the note validator is also equipped with one mini-USB port.

10p connector

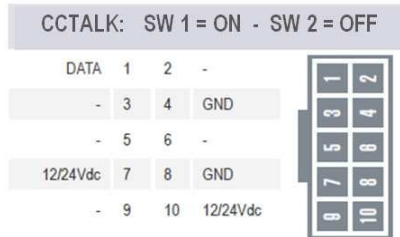
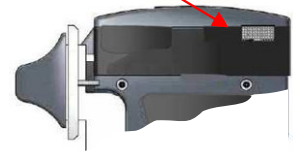

Pin	Signal	Function	Pin	Signal	Function
1	CCT	CCT Data (active low)	6	NC	Not connected
2	NC	Not connected	7	Vcc	+12/24 Vdc (Power supply)
3	NC	Not connected	8	Vss	GND (Power supply)
4	NC	GND	9	NC	Not connected
5	NC	Not connected	10	Vcc	+12/24 Vdc (Power supply)



Pin	Signal Total. / Paral.	Function: Totaliz. / Parallel	Pin	Signal Total. / Paral.	Function: Totaliz. / Parallel
1	(!) ENABLE = - / PARAL. OUT5	Enable TOT. = GND / Parallel 100 €	6	VOID / PARAL. OUT1	VOID / (active Low) Parallel 5€
2	VOID / INH + (!!)	VOID / Inhibit = +3V+30V	7	Vdc	+ 12÷24 Vcc / + 12÷24 Vcc
3	VOID / PARAL. OUT3	VOID / (active Low) Parallel 20 €	8	GND	GND / GND
4	GND	GND / GND	9	TOTALIZER / PARAL. OUT2	(active Low) Credit Total. / Parallel. 10 €
5	VOID / PARAL. OUT4	VOID / (active Low) Parallel 50 €	10	Vdc	+ 12÷24 Vcc / + 12÷24 Vcc

**PULSE TOTALIZER:** if pin1 = GND ---> validator is enabled. If pin1=floating or +3V+30V ---> validator is disabled.  
**PULSE PARALLEL:** if pin2 = floating or GND ---> validator is enabled. If pin2 = +3V+30V ---> validator is disabled.

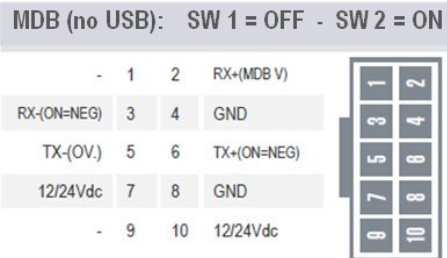

Pin	Signal	Function	Pin	Signal	Function
1	NC	Not connected	6	TX +	Tx ( Active low )
2	RX +	Rx (+V MDB)	7	Vcc	+12/24 Vdc (Power supply)
3	RX -	Rx (Active low)	8	Vss	GND (Power supply)
4	GND	GND	9	NC	Not connected
5	TX -	Tx (0V MDB)	10	Vcc	+12/24 Vdc (Power supply)

### 4.3.4 Dip-switch row and unit setting

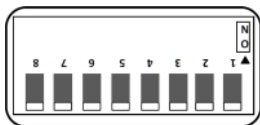

The Dip-Switches allow to set the communication mode (interface protocol) and other useful features. The DS row is located on the left side of the validator.

**BEWARE! The functions that can be set by Dip-Switch in the BillyOne UN1 do not correspond to the ones in the previous BillyOne generation.**

**Examples of communication settings of the interface by DS5, DS6, DS7**

Ex. 1: for operation in ccTalk mode, move the dip-switch 1 to ON:

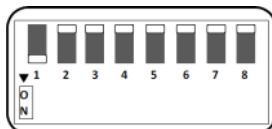

Ex. 2: for operation in Pulse mode, 1 € = 1 pulse, 200mA pulse length:

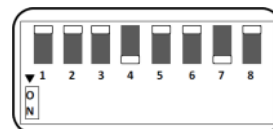

SW N°	DIP-SWITCH FUNCTIONS		
SW1 & SW2	SW1	SW2	<b>Protocol Interface Mode</b>
	OFF	OFF	Pulse
	ON	OFF	ccTalk
	OFF	ON	MDB
	ON	ON	SAS
SW3	SW 3		<b>Pulse communication modes</b>
	OFF		Pulse Parallel Outputs (Out 1 = 5€, Out2 = 10€, Out3 = 20€, Out4 = 50€, Out5 = 100€)
	ON		Pulse Accumulator Output (see SW 4 / SW 5)
SW4 & SW5	SW4	SW5	<b>Accumulator value (only for Pulse mode)</b>
	OFF	OFF	5 Euro = 1 Pulse
	OFF	ON	5 Euro = 5 Pulses (1 Euro = 1 Pulse)
	ON	OFF	10 Euro = 5 Pulses (5 € disabled)
	ON	ON	5 Euro = 10 Pulses (1 Euro = 2 Pulses)
SW6	SW 6		<b>Acceptance rate / Anti-fake Security level</b>
	OFF		!!!! Acceptance 98% = Standard security level !!!!
	ON		Acceptance 92% = High security level (false notes mode)
SW7	SW 7		<b>Pulse length (only for Pulse mode)</b>
	OFF		100 msec. / 100 msec. (time ON / time OFF)
	ON		200 msec. / 200 msec. (time ON / time OFF) - re-programmable
SW8	SW 8		<b>Activation of Anti-Fraud signals</b>
	OFF		Anti-fraud override enabled: first 3 attempts are signaled, + 2 attempts cause 15' inactivity, with yellow flashes (see ** in Table "AF Modes")
	ON		Anti-fraud override disabled: the note gets rejected with no fraud attempt signals (see *** in Table "AF Modes")

**Please pay attention: after any change in the DS settings, power must be turned off and then on again, so that the validator can detect the set operation mode.**

(\*) The pulse length can be modified by the dedicated function available in the Alberici Upg programming software menu. Such programming software is available for download in our Website.

### Table AF: ANTI-FRAUD OPERATION MODES

(\*\*) Dip-Switch SW8 = OFF:

Progressive attempt no.	Reaction of the Validator	Measure to be taken	Progressive attempt no.	Reaction of the Validator	Measure to be taken
1st	Remains in operation	-	4°	> error (sequences of 3 red flashes)	Switch off and then on
2nd	Remains in operation	-			
3rd	> error (sequences of 3 red flashes)	Switch off and then on			
<b>After the 5th fraud attempt (3 yellow flashes), it is necessary to wait for automatic restore of service. Take care not to switch the device off.</b>					

(\*\*\*) Dip-Switch SW8 = ON:

**Any attempt at "fishing" will cause the note to be rejected, without showing any visible signal.**

**Solid yellow light**

**Error in ccTalk communication.  
Check voltage level (must be 24Vdc). Power the device off and on.**

### 4.3.5 Enable/Disable programmed denominations

All the notes of the programmed currency are factory enabled. The denominations are stocked in the validator memory. It is possible to disable/re-enable one (or more) denomination(s) by following the steps described below:

#### - *Disabling banknotes*

Move DS No. 1, DS No. 4 and DS 5 to ON position

Turn power on: the front plate LED will light up white. Insert the banknote that you want to disable. The LED will blink yellow 3 times when the note is returned, to mean that the note has been disabled. Insert the following banknote that you want to inhibit, or switch power off and on again.

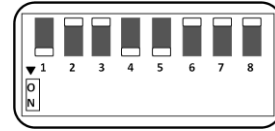

#### - *Enabling banknotes*

Move DS No. 1 and DS No. 4 to ON position. Turn power on: the front plate LED will light up white. Insert the banknote that you want to enable. The LED will blink green 3 times when the note is returned, to

mean that the note has been enabled. Insert the following

banknote that you want to enable, or switch power off and on again.

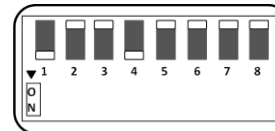

When finished, put all the DS in their original position (eg. for operating in ccTalk, all DS must be in OFF position).

**NOTICE:** enabled and disabled banknotes are signalled at device switch-on, depending on the number of coloured flashes from the faceplate LED.

The LED in the front panel flashes as many times as the total number of the programmed denominations; e.g., for the EURO, it flashes 5 times (1st flash = € 5 banknote, 2nd flash = € 10 note, 3rd flash = € 20 banknote, 4th flash = € 50 banknote, 5th flash = 100 € banknote). If the LED flashes green, the bill is enabled; if it flashes yellow, the note is disabled.

For example, if the denominations of 5, 10, 50 € are set to be accepted, and the denominations from 20 and 100 € are set to be inhibited, the 1st, 2nd, and 4th flashings will be in green colour, while the 3rd and 5th flashings will be in yellow.

### 4.3.6 ccTalk Interface circuit

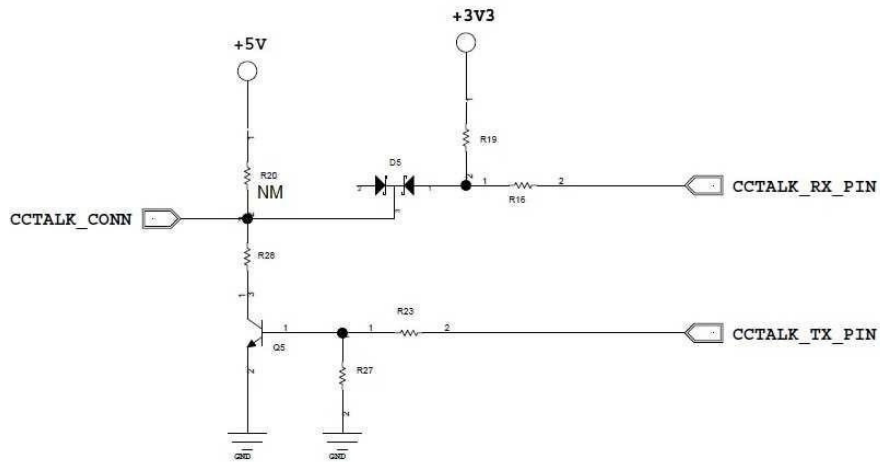

**The Note Validator operates by default by 16bit CRC Checksum.**  
 To convert 16bit to simple checksum (8bit), please make use of the Alberici Update Software (available on <https://www.alberici.it/eng/products/note-validators/without-stacker/billyone>, in the Download section).

Open the Options menu and set checksum as follows:  
 1) **OPTIONS:** choose and open **ADVANCED OPTIONS:** choose "Menu Tool: Enable all tools"  
 2) **TOOLS:** "Set device parameters"; choose either "simple checksum" (8-bit) or "16-bit CRC", then press OK.

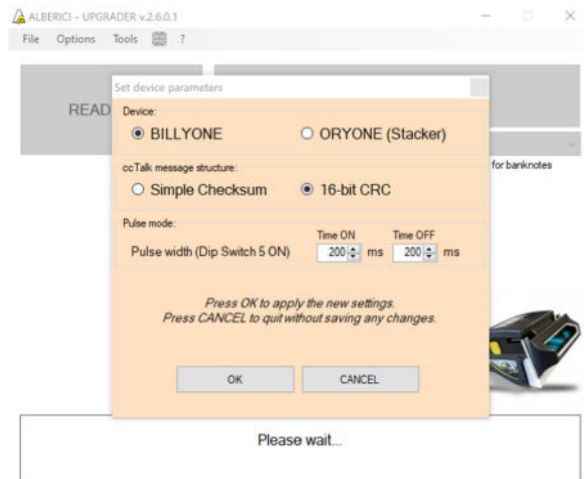

### 4.3.7 MDB 10p output

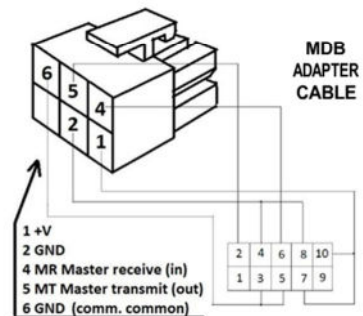
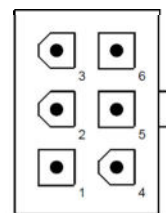
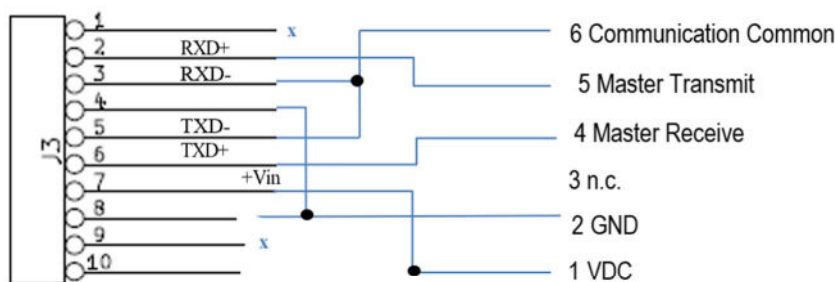

When setting the reader for MDB protocol (see 4.3.4 Dip-Switch Settings), the 10p outputs must be converted to the 6p MDB standard cable from the master pcb of the machine. Adapter cable is available (ref. S-031005-000).

The MDB version supports all MDB standard commands (level 1).

#### 4.3.8 Supported ccTalk headers (16-bit Cyclic Redundancy Check)

##### Supported Specifications

###### **CcTalk supported specifications list**

1. cctalk Generic Specification Issue 3.2
2. cctalk Expansion for Bill Validators Issue 2.1

##### Supported Command Headers

###### **CcTalk supported commands list**

###### **1. Core Commands**

- Header 192 - Request build code
- Header 244 - Request product code
- Header 245 - Request equipment category id
- Header 246 - Request manufacturer id
- Header 254 - Simple poll

###### **2. Core Plus Commands**

- Header 001 - Reset device
- Header 004 - Request comms revision
- Header 241 - Request software revision
- Header 242 - Request serial number

###### **3. Bill Validator Commands**

- Header 145 - Request currency revision
- Header 152 - Request bill operating mode
- Header 153 - Modify bill operating mode
- Header 154 - Route bill
- Header 156 - Request Country scaling factor
- Header 157 - Request bill id
- Header 159 - Read buffered bill events
- Header 197 - Calculate ROM checksum
- Header 213 - Request Option flags
- Header 216 - Request data storage availability
- Header 227 - Request inhibit status
- Header 228 - Modify master inhibit status
- Header 230 - Request inhibit status
- Header 231 - Modify inhibit status
- Header 247 - Request variable set

## 5. Fault and functional messages

### 5.1 Error warnings: red flashes - yellow flashes - blue flashes

The number of flashes emitted from the front plate allows to check the possible reason for malfunction.

N°of red flashes	Description
1	Validator is open
2	Jammed banknote
3	Fraud attempted
5	Adjust optics
7	Stacker full: remove stacked notes or replace by an empty stacker
9	Low power supply
11	Check encoder+motor efficiency
12	Check stacker motor efficiency
14	ROM error

If ccTalk communication drops off, the validator face led will lit up solid yellow:

<b>Solid yellow light</b>	Error in ccTalk communication. Check voltage level (12 or 24Vdc). Power the device off and on.
---------------------------	---

<b>Regular blue blinkings</b>	Position of dip-switch 1 is not compatible with host communication mode.
<b>Sequences of 2 blue blinks</b>	The stacker box has been removed, or its detector is damaged

### 5.2 Anti-fraud stop

The banknote reader is equipped with a security device that gets activated in the event of fishing fraud attempts repeated over a period of time.

This device can be set through the dip-switch SW8 to operate by "soft" mode (\* DS8 = ON) or by "extended" mode (\*\* DS8 = OFF).

(\*) Dip-Switch SW8 ON

**Any attempt** at "fishing" will cause the note to be rejected, without showing any visible signal.

(\*\*) Dip-Switch SW8 OFF

Attempt	Validator reaction	Do as described below
1°	Remains in service	-
2°	Remains in service	-
3°	> error (3 red flashes)	Reset (switch off then on)
... n° ...	> error (3 red flashes)	Reset (switch off then on)

**After the 5th fraud attempt (3 yellow flashes), it is necessary to wait for automatic restore of service. Take care not to switch the device off.**

NOTICE: no error status is communicated to the machine, so that the latter does not go out of service, and then continue to maintain the other functions working.



## 6. Maintenance

### 6.1 Manual cleaning

The ability of acceptance may decrease due to the accumulation of dust and cellulose dust released by banknotes during transit, or because of residues or sprays, which may spread on the detecting sensors and on transmission parts. It is therefore recommended that you **clean these parts monthly**, as indicated below.

1. Turn off the power and unplug the cable from the 10-pin connector interface. Press the yellow button C, located under the reader, to release the main body from the faceplate, and slide it backwards.

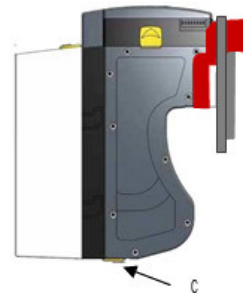

2. Move the D button upward, hold it while sliding the cover backwards; then lift the latter up and rotate it 180° to the right side.

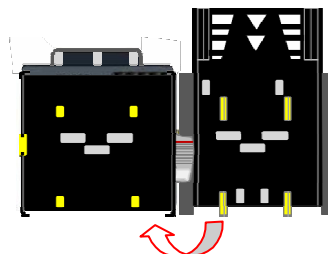
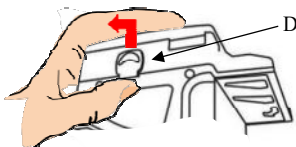

3. Gently wipe the sensors with a clean, lint-free tissue, or with a cotton swab, or with a small sponge, possibly moistened with isopropyl alcohol.
4. Completely remove the dust and residues from the 4 silicone rollers, and from the 4 elastic matching wheels which are located in the lower surface of the upper lid. To remove the most stubborn dirt from rollers and wheels, use *isopropyl alcohol*.

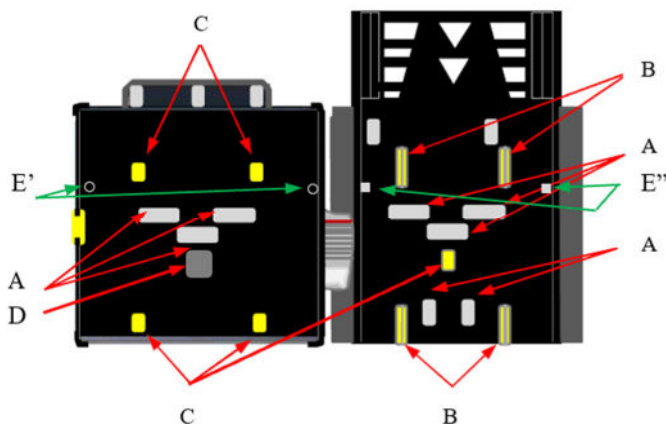

**PAY ATTENTION:** *do not use organic detergents (ex. alcohol, thinners, or petrol). Use only isopropyl alcohol.*

- A. Optic Sensors
- B. Traction Rollers
- C. Elastic matching wheels
- D. Magnetic sensor (only in LB-MU02, LB-LU11, LB-MU12)
- E'-E''. Alignment sensors (spray pressurized air into the holes)

5. Check that the two sensor pairs S' and S'' matching the stacker and the banknote (two pairs on the stacker back and two on the inner side of the case) are clean (see section 5.1: Sequence of 2 blue blinks).

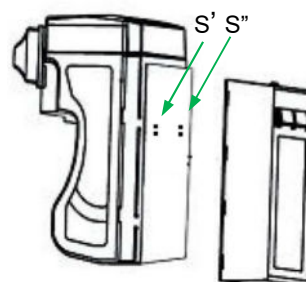

## 6.2 Jammings

**CAUTION!** Turn off power before opening its upper lid.  
Open the top cover by pressing D, as described in section 6.2.1 (point 2), and pull out the stuck banknote (as well as any other objects that will hinder the transit).

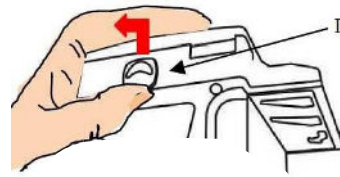

## 7. Calibration

Calibration should be carried out when acceptance rate decreases substantially, and/or after thorough cleaning of the note validator and particularly of its optic sensors glasses.

Full Calibration requires usage of the Alberici Calibration Card (AA-0245).

A more basic calibration (Partial Calibration) can be carried out as well without such Card.

Calibration operation is part of the Firmware Update tool 'AlbericiUpgLetto.exe' (see directions for use "Instructions - ENG - BillyOne, OryOne update", available on the web site).

Launch the 'AlbericiUpgLetto.exe' Software, and open its Tools Menu and select 'Calibration', then choose 'Full Calibration' or 'Partial Calibration'.

### **Full Calibration :**

you will be prompted to use the Calibration card. Place the Card and press OK.

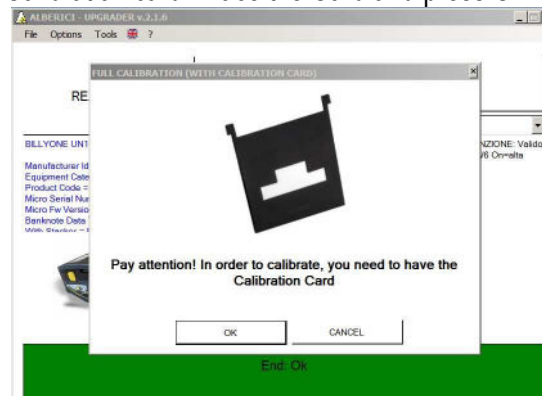

If the 'Enable advanced functionalities' box in 'Options/Advanced' has been ticked, the program will ask to choose between High Sensibility (factory default) and Low Sensibility. Tick the desired choice, then OK.

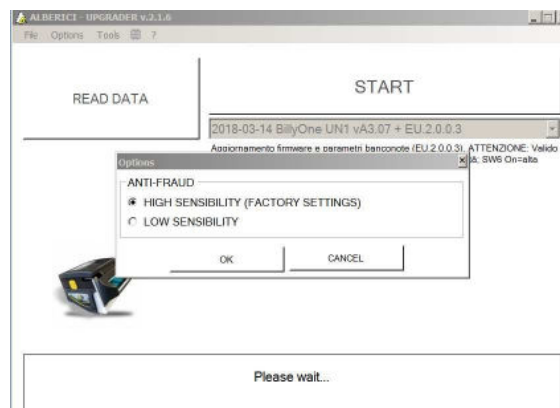

Once made your choice, or straight away if the 'Enable advanced functionalities' box has not been preset, calibration will start. If the card is not in, the system will remind you to insert it and restart the process:

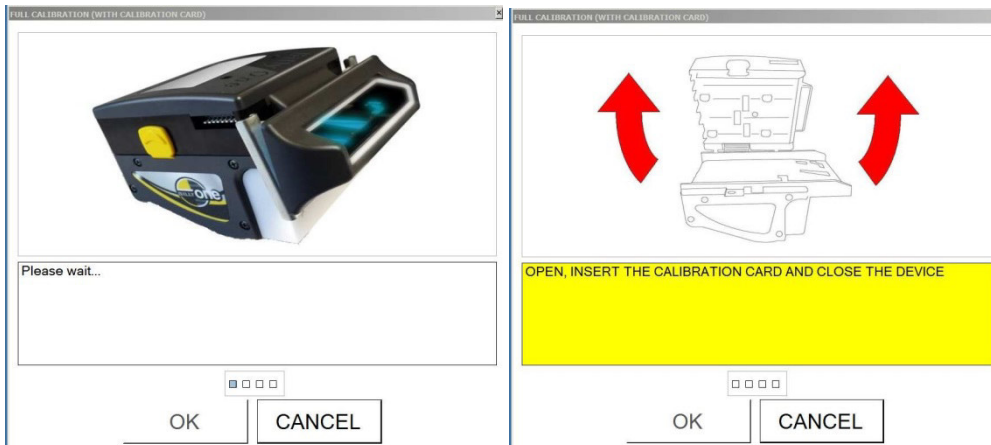

Once positioned the Calibration Card, press OK button and wait until confirmation that process has ended.

### Partial Calibration:

If the 'Enable advanced functionalities' box has been ticked in the 'Options/Advanced', the program will ask to choose between High Sensibility (factory default) and Low Sensibility. Tick the desired choice, then OK.

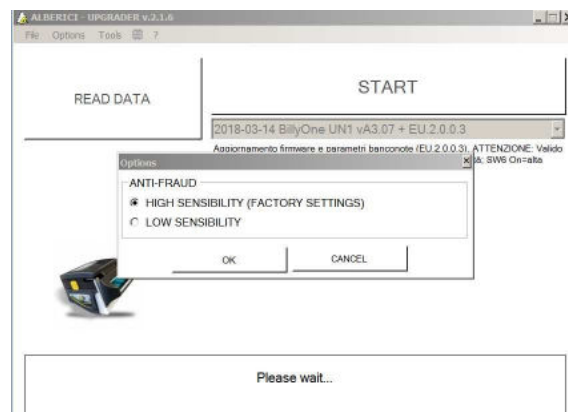

Once made your choice, or straight away if the 'Enable advanced functionalities' box has not been preset, you will be reminded to check that the validator is empty and closed.

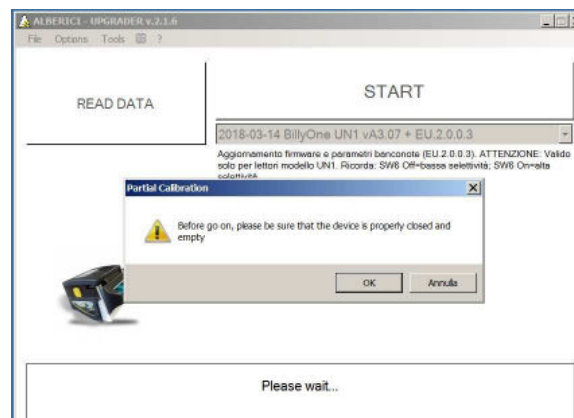

Press OK: shortly after, the program will confirm the end of the Partial Calibration:

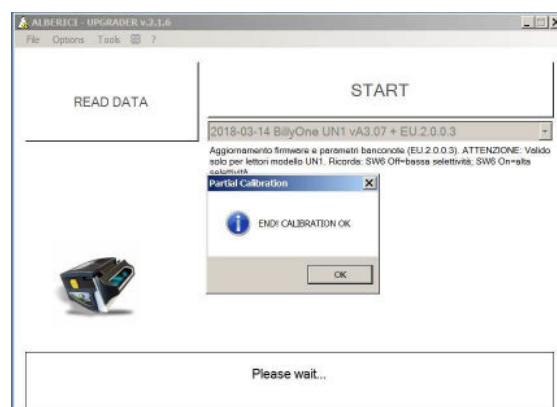

## 8. Disposal of the Product

### WARNING ! DISPOSE OF THIS DEVICE ACCORDING TO THE GOVERNING LAW IN YOUR COUNTRY!



This equipment may not be treated as household waste. Instead, it must be handed over to the applicable collection point for the recycling of electric and electronic equipment. By ensuring that this product is disposed of correctly, you will help to prevent potential negative consequences for the environment and human health, which could otherwise be caused by inappropriate waste handling of this product. For more detailed information about recycling of this product, please contact the Dealer where you purchased this product.

*Ref.: D. Lgs. 151/2005 – Directive 2002/96/EC*

## 9. Terms of Guarantee

The manufacturer will fix malfunctions arising from production faults in this device or its parts within 12 months from the date of sale.

All communications referring to guarantee repairs or replacements must be accompanied by the product serial number and the copy of the sale invoice.

To obtain your guarantee repair, please send the item to the Dealer where you purchased the machine, together with the following documents:

- copy of the sale invoice
- delivery note stating “returned for guarantee repair”
- detailed report of the problem found and the circumstances in which it occurs.

Before sending the product, please get in touch with your Dealer or with Alberici S.p.a. (+39 051 944300); very often, malfunctions can be fixed via a simple phone call, saving you costs and time.

Alberici S.p.a. will verify that warranty is applicable, i.e. that problem is not caused by:

- transport damages
- damages from incorrect installation or wrong configuration
- installation in premises or areas not complying with the prescribed safety requirements
- intentional or unwilling tampering
- wrong or careless use or maintenance
- non-compliance with precautions prescribed (see Chapter 4. Caution)
- natural disasters, vandalisms, intentional or unintentional damage

Guarantee will be considered automatically expired if outer and inner labels are missing. Transport costs of repaired products are at the Customer's charge.

## 10. Customer Service

Alberici S.p.a. will be pleased to offer all the necessary information on use, ordinary maintenance and technical service. Please call (+39) 051 944300 and specify if your request concerns information on use or technical support.

### Appendix 1: List of available currencies <sup>(1)</sup>

AE	AE Dirham UA Emirates	GB	GBP Pound Sterling UK	RO	ROM Lei Romania
BA	KM Marka Bosnia	GE	GEL Lari Georgia	RS	DIN Dinar Serbia
BGN	Leva Bulgaria	HR	HRK Kuna Croatia	RU	RUB Ruble Russia
BR	BRR Rial Brazil	HU	HUF Florint Hungary	SE	SKK Krona Sverige
CH	FRS Franc Switzerland	IL	SKL Shekel Israel	UA	GRV Hryvnia Ukraine
CH-EU	FRS Franc Switzerland + Euro	KZ	KZT Tenge Kazakhstan	UZ	UZB Som Uzbekistan
CZ	CZK Kruna Czech Republic	LBP	Pound Lebanon	US	US Dollar USA ( <i>only versions with Magnetic Sensor</i> )
DK	DKK Krona Denmark	MD	MDL Leu Moldavia	ZAR	Rand South Africa
EU	Euro Europe	MXN	Peso Mexico		
		PL	PLN Zloty Polska		

Please contact us for any other currencies that you may need

(1) As of 31.12.2022



## DICHIARAZIONE DI CONFORMITÀ



DIRETTIVA 2014/35/UE - DIRETTIVA 2014/30/UE

La ditta **Alberici S.p.A.**, avente sede in via **Ca' Bianca, 421, 40024 Castel San Pietro Terme (BO)** – Italia,

### DICHIARA

Che il sistema classificato nella famiglia di prodotto **apparecchio elettrico d'uso domestico e simile – scheda elettronica**, finito di costruire ed assemblare il      /      /     , identificato univocamente da:

Modello	Configurazione	Version	N° di Serie e/o matricola
<b>ORYONE</b>	<input type="checkbox"/> <b>ccTalk - Pulse</b> <input type="checkbox"/> <b>MDB - Pulse</b>	<input type="checkbox"/> <b>Magnetic Sensor</b>	-----

Essendo realizzato conformemente al modello campione denominato ORY ONE avente matricola (numero di serie) LB0-1000962\_1215, finito di testare positivamente ai fini EMC e LVD (rapporto 7037CE-ORY ONE.doc) il 18/05/2015, dalla STP S.r.l., con sede legale in via P.F. Andrelini, 42, 47121 Forlì (FC), Italia e sede operativa in via San Donnino, 4, 40127 Bologna (BO), Italia, risulta essere conforme a quanto previsto dalle seguenti direttive comunitarie:

- a) le norme armonizzate (per i punti applicabili):
- CEI EN 55014-1 (CEI 110-1);
  - CEI EN 55014-2 (CEI 210-47);
  - CEI EN 55022 (CEI 110-5);
  - CEI EN 55024 (CEI 210-49);
  - CEI EN 60065 (CEI 92-1);
  - CEI EN 60335-1 (CEI 61-150);
  - CEI EN 60335-2-82 (CEI 61-226);
  - CEI EN 60950-1 (CEI 74-2);
  - CEI EN 61000-3-2 (CEI 110-31);
  - CEI EN 61000-3-3 (CEI 110-28);
  - CEI EN 61000-4-2 (CEI 210-34);
  - CEI EN 61000-4-3 (CEI 210-39);
  - CEI EN 61000-4-4 (CEI 210-35);
  - CEI EN 61000-4-5 (CEI 110-30);
  - CEI EN 61000-4-11 (CEI 110-29);
  - CEI EN 61000-6-1 (CEI 210-64);
  - CEI EN 62233 (CEI 61-251).
- b) In conformità ai requisiti essenziali di sicurezza della Direttiva Bassa Tensione:
- 2014/35/UE del 26 Febbraio 2014;
  - L. 791 del 18 Ottobre 1977 e s.m.
- c) in conformità ai requisiti essenziali di sicurezza della Direttiva Compatibilità Elettromagnetica:
- 2014/30/UE del 26 Febbraio 2014;
  - D.Lgs. 194 del 06 Novembre 2007

Che conferiscono la presunzione di conformità alla Direttiva 2014/30/UE

Castel San Pietro Terme (BO), Italia li,      /      /     

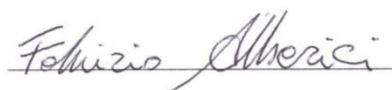
  
Il Presidente

### Alberici S.P.A.

Progettazione e produzione sistemi di pagamento, accessori per videogames e vending machines

Via Ca' Bianca, 421, 40024 Castel San Pietro Terme (BO), Italia.

Telefono: +39-(0)51-944300 r.a. – Fax: +39-(0)51-944594 – P.Iva: 00627531205





**NOTICE**

Alberici reserves the right to change at any time any part in the present manual, as well as in the product and in its functions, without previous notice, to the aim of continuously improve the quality of the products.



Progettazione e produzione di sistemi di pagamento, accessori per videogames e macchine vending  
Design and manufacture of payment systems, accessories for videogames and vending machines

Via Ca' Bianca 421  
40024 Castel San Pietro  
Terme (BO) – ITALY

Tel. + 39 051 944 300  
Fax. + 39 051 944 594

<http://www.alberici.net>

[info@alberici.net](mailto:info@alberici.net)