

Hira 1 ARM POS Money Changer VPOS

Operator's Manual

Rev. 2.02 EN

HIRA 1 ARM POS



Operator's manual

CE



Via Cà Bianca, 421 - 40024
Castel San Pietro Terme (BO) - Italy

Progettazione e produzione di sistemi di pagamento e accessori per macchine Gaming, Vending e Car-Wash Design
and manufacture of payment systems and accessories for the Industries of Gaming, Vending and CarWash

Tel.: +39.051.944300
Fax.: +39.051.944594

Web: www.alberici.net
E.mail: info@alberici.net

NOTICE

This manual has been prepared with the utmost care. Nevertheless, it is not possible to assure at any time the exact correspondence of the descriptions to the product features. Alberici SpA shall not be held liable by the User for any damage, losses, or third-party claims arising from any uses of the manual or of the product.

CONTENTS

| | |
|-------------------------------------|----|
| 1. Package content..... | 4 |
| 2. Component names..... | 4 |
| 3. Product description | 5 |
| 4. Warning..... | 5 |
| 5. Installation..... | 6 |
| 6. Operation..... | 8 |
| 7. System configuration | 11 |
| 8. Messages | 25 |
| 9. Cleaning the Note Validator..... | 28 |
| 11. Disposal of the product..... | 29 |
| 12. Terms of Guarantee | 29 |
| 13. Customer Service..... | 29 |

| STORICO REVISIONI | | | |
|-------------------|----------|--|--------------------------------|
| Revisione n° | Data | Modifica | Note |
| Creazione | 27.12.12 | Creazione | Scheda CMS |
| Rev. 1.01 | 23.09.14 | Nuovo Design | |
| Rev. 1.02 | 10.01.14 | Sostituito BillyOne a Taiko | |
| Rev. 1.03 | 08.10.14 | Abilit./Disabil. Reset Credito Residuo | FW v. 1.14 |
| Rev. 1.04 | 18.02.15 | Funzioni abilitazione/disabilitazione e erogazione via GSM. | FW v. 1.16 |
| Rev. 1.05 | 10.03.15 | Aumentato timeout visualizzazione valore svuotato. Inserito 1' Timeout di uscita in menu svuotamento | FW v. 1.18 |
| Rev. 1.06 | 27.06.15 | Abbassato timeout cancellazione automatica credito residuo | FW v. 1.19 |
| Rev. 1.07 | 29.04.16 | Inserito lettore ACS | FW v. 1.23 |
| Rev. 1.08 | 15.07.18 | Nuova livrea nera | FW v. 1.26 |
| Rev. 1.09 | 14.02.20 | Integrazione Tabella Pagamenti | FW v. 1.34 |
| Rev. 2.00 | 04.06.20 | Integrazione VPOS Touch Nayax | FW v. 1.38.04NL - ARM v. A1.03 |
| Rev. 2.01 | 16.12.22 | Nuovo cabinet v. 3 e Modulo di alimentazione integrato MP1 | FW v. A2.11 |
| Rev. 2.02 | 03.07.23 | Compatibilità con Nayax v. 2.4.0.4 e retrocompatibilità con v. 2.0.1.9. Eliminato doppio passaggio con carta di credito da v. Nayax 4.0.23.4. Aggiunti: 1) Refill Manuale + Auto; 2) Inversione pulsanti | FW v. A2.22 |

Dear Customer,

we would like to thank you and congratulate for your choice. We trust that you will appreciate the quality and performance of the HIRA ONE automatic Change Machine.

This machine operates by cctalk protocol, the well-established serial communication mode that provides security and precision.

Please read carefully this handbook, to obtain the most from your machine.

1. Package content

The package contains:

1. the Alberici HIRA ONE Change machine
2. 2 pairs of metal keys (for Open/close lock and for Refill lock)
3. the power cable (see inside of money box)
4. the instruction manual (this manual)

This product has been packed with the utmost care. In the case that you receive it damaged or incomplete, please notify immediately your findings to the Carrier.

2. List of components

| POS. | COD. | DESCRIPTION |
|-------|--|--|
| A | AE-0806 <i>or</i> A-PW0002 | Power supply box RD-125 <i>or</i> MP1 integrated Power Module with Hub pcb |
| B | SH-5A21 <i>or (for POS):</i> SH-5L21 | 1 x ChangeOne CMS ARM pcb, 2x16 display <i>or else, if preset for POS:</i> 1 x ChangeOne CMS ARM Full pcb, 2x16 dspl. |
| C | AA-0177 | Hub pcb for Peripheral units |
| D | K-02C-020110 | HopperOne S11 ccTalk STD + Sector 100-coin capacity extension no optics |
| E | AA-0309 | Capacity extension SECTOR 100 |
| F | LB-LC1 <i>or else:</i> LB-MC02 | BillyOne ccTalk (combined with coin acceptor) <i>Or else:</i> OryOne ccTalk (no coin acceptor) |
| G | PL-MK21-ET6H | Halo square 21 RGB illuminated pushbutton |
| H | AM-1509 | Flat key lock keyed different, L=21mm |
| I | AM-1305 <i>or else:</i> HR1-011A-P00 | Plastic Coinbox "A" <i>Or else, in version with Coin Acceptor:</i> Metal Coinbox |
| (L) | GE-66SU + IM-N000-0L10 | AL66S coin acceptor (<i>only with BillyOne</i>) + PP coin entry bracket |
| (M) | C-140102 | VPOS Touch Nayax 3G EU-Marshall |
| (N') | A-CM0068 | Interface pcb for WL Valina POS |
| (N'') | A-CM0059 | Interface pcb for VPOS Touch Nayax |
| (O) | CH-BC01-0001 | ACS RFID Card/Key reader |

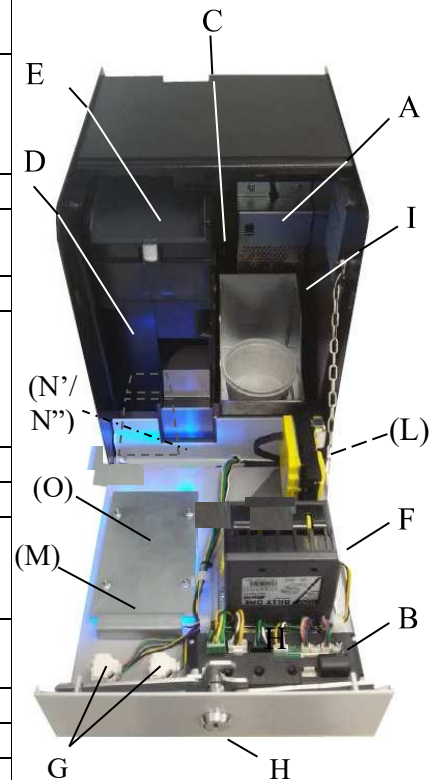

3. Product description

3.1 General data

| Technical specs | HIRA ONE |
|---------------------------|---|
| Size max: | 283 mm (l) x 460 mm (h) x 367 mm (p) |
| Size with floor-stand: | 283 mm (l) x 1410 mm (h) x 367 mm (p) [floor-stand 275 (l) x 950 (h) x 367 (p)] |
| Weight: | 24,5 Kg - 43 Kg with floor-stand |
| Voltage: | 230 Vac - 50 Hz |
| Nominal power: | 140 W max 0°C |
| Operation temperature: | ÷ +50°C |
| Installation: | Indoor - on desktop, or on floor-stand, or wall-mount |
| Coin capacity: | HIRA 1 (S11): 2000 (0,50 o 1 €), 1800 (2 €) HIRA D (AH4): 1800 (mixed denomin.) |
| Components: | |
| Power supply unit | MP1 Power Module, Power switching 340W with fan and noise filter |
| Control board | CMS ARM Full ChangeOne p.c. board, with DISPLAY LCD 2x16 |
| Note validator | BILLYONE, <i>or:</i> ORYONE (with stacker) |
| Pay-out Hopper | HopperOne S11 (HIRA ONE), <i>or:</i> HOPPER AH4 (HIRA D) |
| Coin acceptor | AL66S cctalk (<i>N.B.: not available in combination with OryOne</i>) |
| POS Terminal (optional) | VPOS Touch Nayax 3G EU-Marshall, or preset for WorldLine Valina |
| Card/Key reader (option.) | ACS RFID Card/Key reader |
| Remote audit (optional) | Alberici GSM-GPRS or GPS/GSM/GPRS (*) |

Notice: Euro is the preset currency. Different currencies can be set by using the Alberici Babbel software.

(*) The system requires a SIM card enabled for data traffic, and the subscription to the Portal ARGO if you want to control the machine via the Internet. It is recommended to check carefully that the SIM card functions properly in the area. Else, Alberici provides its B2B SIM Card, that connects automatically to the most powerful network in the area.

3.2 Available functions

- Change of notes / coins into 1 coin/token denomination (S11), or 3-coin denominations (AH4)
- Purchase of tokens by cash money or by POS, with or without Bonus (Hopper S11)
- Credit load on RFID User Cards and keys (only if equipped with optional ACS reader)
- Control of accounts via display (by board keys)
- Programmable via menu (by on-board board keys)
- Selection of courtesy language on display (not available in versions with POS)

4. Warning



- Comply with the instructions in this manual
- Switch power off before any maintenance operation
- Use only within the recommended temperature/humidity range
- Do not expose the machine (and especially the note acceptor front plate) to direct sun light or to incandescent light (> 3000 Lux)
- When in presence of car exhaust gas or smoke, clean and check the components (the note acceptor in particular) regularly and frequently.
- Do not favour contact with dusts or chemical moisture or sprays, water or other liquids
- Install indoor
- Wipe clean by a dry piece of cloth (or slightly wet with alcohol)
- Do not use thinners or organic solvents
- The note acceptor could reject (or get jammed by) stained notes, or worn out, wet, wrinkled, torn, dog-eared, oil-smearred, with sticking tape or similarly affected.

NOTICE: Tokens or coins with very irregular shape are not accepted

5. Installation



**PAY ATTENTION: IT IS ESSENTIAL TO FASTEN THE MACHINE TO A SOLID WALL BY USING EXPANSION BOLTS
USE OF THE WALL SLAB (code no. HR1-013A-V06) is recommended.**

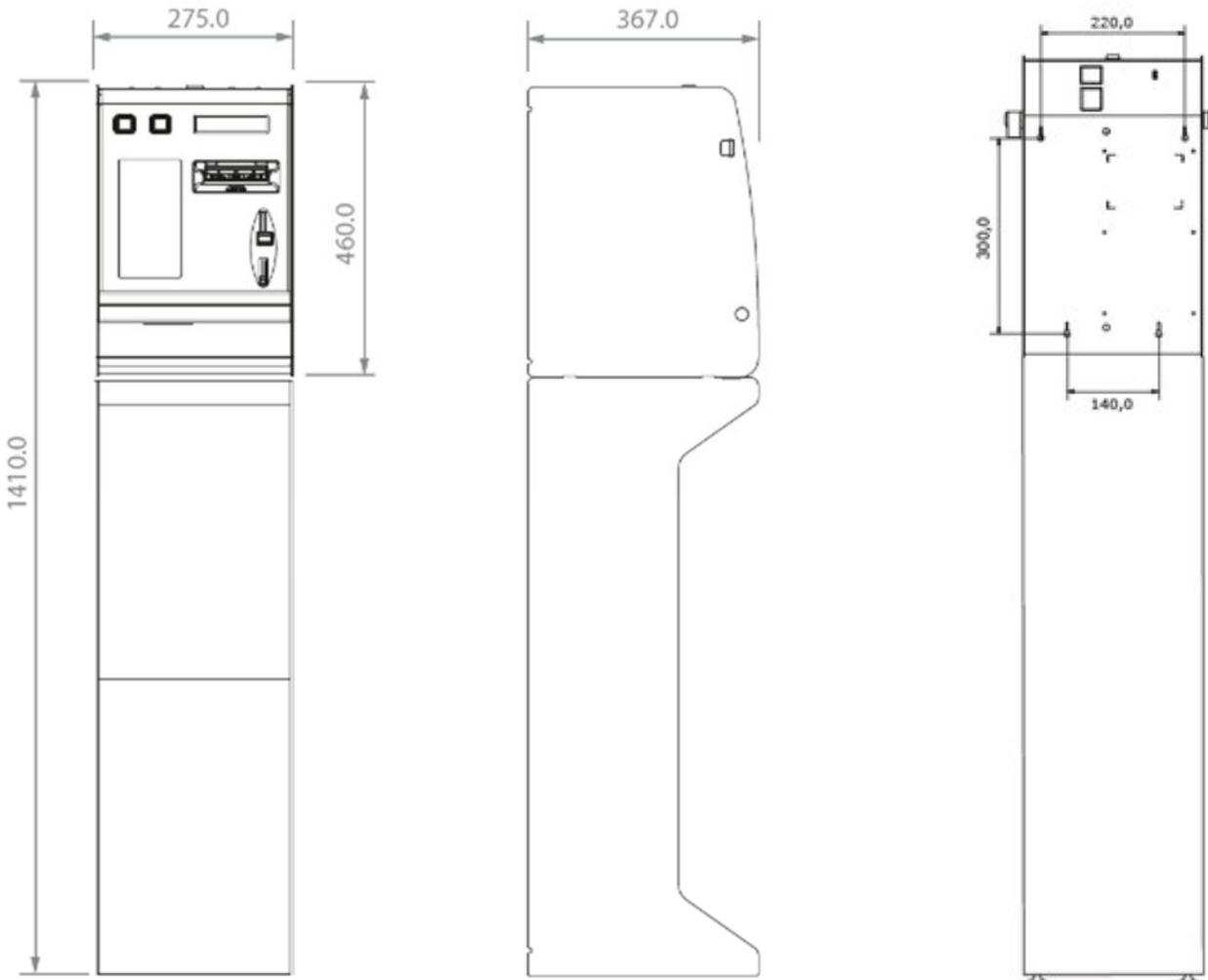

All measures in mm

Put the Change Machine in place and fasten it to the wall by fitting expansion bolts through the rear side 4 “x” holes. The large holes at the foot allow securing the machine by a binding chain.

The wall fixing slab HR1-013A-V06 makes installation extremely easy (see drawings in the next page). Once fastened the slab to the wall, the unit can be hung to the 4 set hooks, and then fixed through the 2 “z” holes.

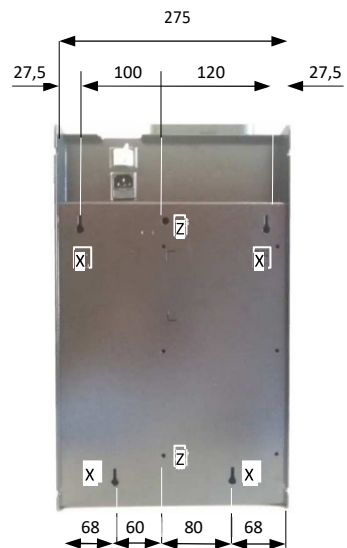

WALL-MOUNT SLAB (HR1-013A-V06):

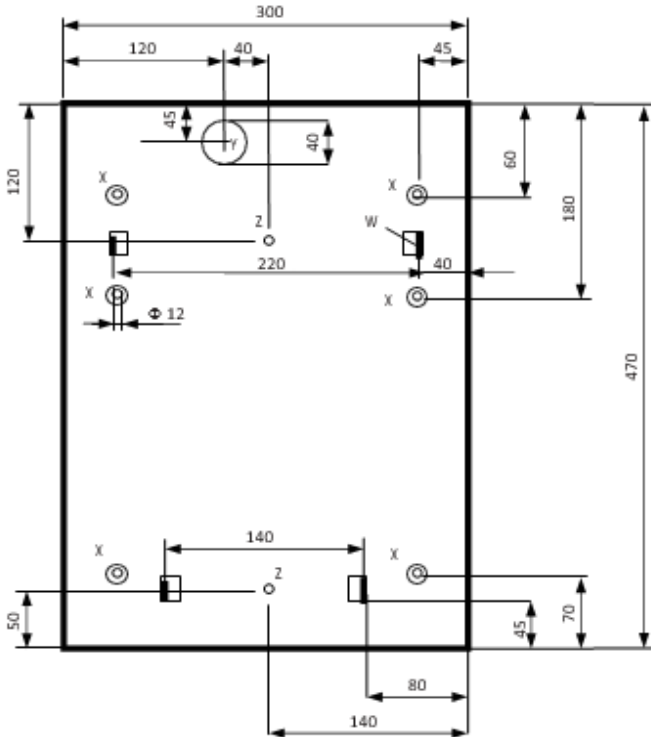

Prepare the tunnel for the power cable in the wall (corresponding to “Y” Hole in the slab).

Fasten the slab to the wall by sturdy expansion bolts, through the 6 “X” (Φ 12 mm) holes.

Connect the cable to its socket behind the machine, and hang the latter on the 4 “W” supporting hooks.

Fix the unit to the slab by M8 screws through the two “Z” threaded holes - unless you mean to often remove and re-hang the machine up, by the four “w” hooks.

GETTING STARTED:

PAY ATTENTION: FILL THE HOPPERS ONLY WHEN THE MACHINE POWER IS OFF.

Open the door and locate extensions capacity on top of the hopper. Unlock the latch A (white slide) of the cover and slide the latter fully out towards the outside, until is positioned as a pilot chute: pour into the hopper the coins or tokens to be dispensed as change. Unlock again the latch A and slide the cover back to “closed” position. Close the door of the machine.

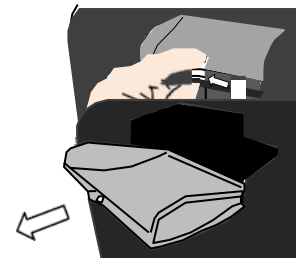

Plug the power cable in, and turn the main switch on. Component check and self-setup shall start automatically. At the end, a message informs that the machine is ready for operation, showing what coin/token value will be paid in exchange for notes and coins introduced, as well as a welcome wording (Operator enters Promo text, see Sect. 7.3.10).



This message takes shifts with:







As soon as the control board enables the note acceptor, the latter’s front slot flashes once in blue colour for each enabled note, or once in red for each disabled note. For instance, if the 5, 10, 20 Euro notes are enabled, and the 50 and the 100 Euro notes are disabled, the front slot will flash 3 times in blue colour and 2 (twice) in red. The machine is now ready to operate.

In the stand-by condition, the buttons of all available programs are illuminated in blue light.

If available in the machine, the ACS RFID reader must be first initialized; the Master/Owner key/card and the Manager/Operator key/card must be initialized as well. The Manager/Operator key/card is generally used for Service operations (see Section 7.3.5.4).

By means of the Master/Owner key/card, User key/cards can be created too, by which Users may purchase Tokens or services from compatible ACS Readers (i.e. same PIN as the ACS Reader in the machine) placed in other units. The credit in the key/cards can be loaded or topped up in the Hira machine by inserting cash in the coin acceptor or in the note validator (see Section 6.4.1).

6. Operation

Three pushbuttons are available: the ones marked “SEL-“  and “Language/SEL+”  allow the User to choose the coin (or token) value he wants back as change. The “OK” button  will confirm the selected option. The “Language/SEL+” button  allows the User to get display messages in his preferred language: default languages are Italian, English, German, French, Dutch; other languages can be loaded by using the Alberici Babel software.

6.1 MANUAL MODE

6.1.1 CASH: insert cash money until the desired amount is reached. Add money until the amount searched for is reached, then press the OK button to collect coins/tokens. If the machine is set to Tokens and the Bonus has been programmed (see section 7.3.8), put money in until the desired amount is reached, then press the OK button.

 *The Pay-out Table is available only for TOKEN dispensing.*

6.1.2 POS: POS operation is available if the machine menu has been set up to deliver TOKENS only.

 If the machine is set for dispensing Coins, the POS terminal will get automatically disabled. Only single-denomination hoppers are compatible with POS operation; consequently, POS is not available in machines equipped with multi-denomination (Discriminator) Hoppers.

The display prompts to touch the “SEL” button if purchase by credit/debit card is desired:

Press SEL to start CARD mode

press the “SEL“ button: the display will advise the purchase of the lowest amount that has been set in the Pay-out Table (sect. 7.2.5.C.i):

| | |
|--------|-------|
| Select | 2,00€ |
| Token | 1 |

- To select the *number of Tokens* to be purchased, touch the “SEL” / “LANGUAGE/SEL+” buttons of the machine as many times as necessary to show the desired quantity, then:
- Once the choice is made, confirm by the OK button, and tap the ChipCard on the POS Terminal:
- The machine will dispense the selected number of tokens, and the bank network will deduct the equivalent amount from the Credit/Debit Card account.

| | |
|--------|---------|
| Select | 6,00€ |
| Token | > 3,00€ |

INSTRUCTIONS
(TAP CARD)
ON THE POS SCREEN

| | |
|-------------|-------|
| Credit | 6,00€ |
| Tokens paid | 3 |

PAY ATTENTION: 30 idle seconds after pressing the SEL- button, the system returns to stand-by.

 *When the machine is set to dispense Tokens in Manual Mode AND the Pay-out Table is enabled and programmed, the POS will obey the Pay-out Table settings (see: Automatic Mode, section 6.2.2).*

6.2 AUTOMATIC MODE

6.2.1 CASH: when cash money is inserted, the display shows the credited amount and the hopper automatically dispenses the corresponding amount in coins or tokens. The display shows the progression of the amount being paid out.

| | |
|-------------|-------|
| Credit | 3,00€ |
| Tokens paid | 1 |

.....

| | |
|-------------|-------|
| Credit | 3,00€ |
| Tokens paid | 3 |

If the Bonus (Tokens) has been programmed, the payout will include the Tokens amount that has been set for (see section 7.3.8).

6.2.1.A PAY-OUT TABLE ENABLED AND PROGRAMMED (for TOKENS only!): if the Operator enables the Pay-out Table (see sect. 7.2.5 C) and programs it (see sect. 7.2.5.C.i), the User will be able to get only the tokens that the inserted money can obtain according to the combination preset. When a note or coin is inserted, the display will show the credited amount, and the machine shall automatically pay-out the tokens that the Operator has pre-programmed for the amount inserted.

The Pay-out Table can also be programmed to pay out more tokens than those that can be purchased based on the credit entered, thus allowing to bestow Bonus as well.

6.2.2 POS: POS payments shall only allow to obtain *only Tokens*.



If the machine is set for dispensing coins, POS operation will be automatically disabled. POS will be available only if the machine is equipped with single-coin Hopper; in machines equipped with multi-coin Hopper Discriminator, the configuration menu shall make the POS option unavailable.

Operation takes place as described in section 6.1.2 POS above, with the provision that *the User will be able to choose only among the payment levels preset by the Operator in the Pay-out Table (see section 7.2.5.C.i). When purchasing through the POS, if Bonus must be awarded, the Pay-out Table must be programmed: this is the only way to bestow POS-purchase bonus.*

PAY ATTENTION: 30 idle seconds after pressing the SEL- button, the system returns to stand-by.

WARNING: If there are not enough coins/tokens in the hopper to fulfil the whole payout request, the remaining credit shall be displayed and retained in memory. Switch off the machine, fill the hopper, and power on again: the remaining credit shall be paid out.

An alternative option is to set the Remaining Credit Menu (see section 7.3.14) so as to cancel the remaining credit - and at the same time record it in the Accounts menu - by switching the machine off and on again.

6.3 AVAILABLE OPTIONS ACCORDING TO DISPENSING MODE

| | DISPENSING MODE | PAY-OUT TABLE | POS |
|-------------------|--------------------------------|---------------------|-----|
| 1 or 2 HOPPERS | TOKENS, AUTOMATIC MODE | YES | YES |
| | TOKENS, MANUAL MODE | YES | YES |
| | TOKENS, MANUAL MODE 2P | YES | YES |
| | COINS, AUTOMATIC MODE | NO | NO |
| | COINS, MANUAL MODE | NO | NO |
| | COINS, MANUAL MODE 2P | NO | NO |
| 2 HOPPERS | TOKENS+RET. CHANGE AUTOM. MODE | YES (Setup TOK/CH.) | NO |
| | TOKENS+RET. CHANGE MANUAL MODE | NO | NO |
| | TOKENS+COINS MANUAL MODE 2P | NO | NO |

6.4 RECHARGE OF CARDS/KEYS

When equipped with the ACS Card/Key reader (see Section 7.3.5.3), the Money Changer can operate as recharger of credit for User Card/Keys. These can then be used to purchase services or goods from nearby self-service dispensers or distributor kiosks, provided that the ACS readers in such kiosks have been initialized with the same PIN as the one in the Change Machine. When the User Card/Key is in the Hira ACS reader, and money is introduced, the display will prompt for pressing any green-lit button to load the credit onto the Card/Key.

6.5 OPERATIONS WITH RFID CARDS/KEYS

If the machine is equipped with the ACS Reader for the RFID Cards/Keys, it is possible to use such Card/Keys to perform useful functions, according to which type of Card/Key is inserted.

6.5.1 Operation with User Card/Key

When inserting a compatible RFID User Card/Key (must be initialized using the same password as the RFID reader - see section 7.3.5.4 *Set up Cashless*), the available credit gets shown, and a pushbutton will light up and flash in green colour.



If more credit must be loaded, insert more coins and/or notes until the desired value is attained, press the greenlit button, then wait until the storing message (“Data are being stored”) disappears, then remove the Card/Key loaded with new credit. The Card/Key can now be used to buy

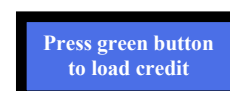

services or products from machines equipped with ACS reader, provided that also such ACS readers have been initialized with the same password as the RFID reader of the change machine.

6.5.2 Operation with Service or Master Key (see also section 7.3.5.4)

Please note that the Service and Master cards/keys must be initialized first (see section 7.3.5.4a).

Insert the Service Card/Key (white) or the Master Card/Key (black) in the ACS reader to get access to the Service Menu. Choose by SEL between the “Accounts” and the “Initialize Keys” options, and confirm your choice by OK. According to the chosen option, it will be possible to:

- 1) check and reset the Accounts Data. By the Master/Owner Card/Key, the Accounts data can be printed out if the machine is connected to the printer (see menu steps in next page and at foot of next page); or,
- 2) initialize the User Card/Keys.

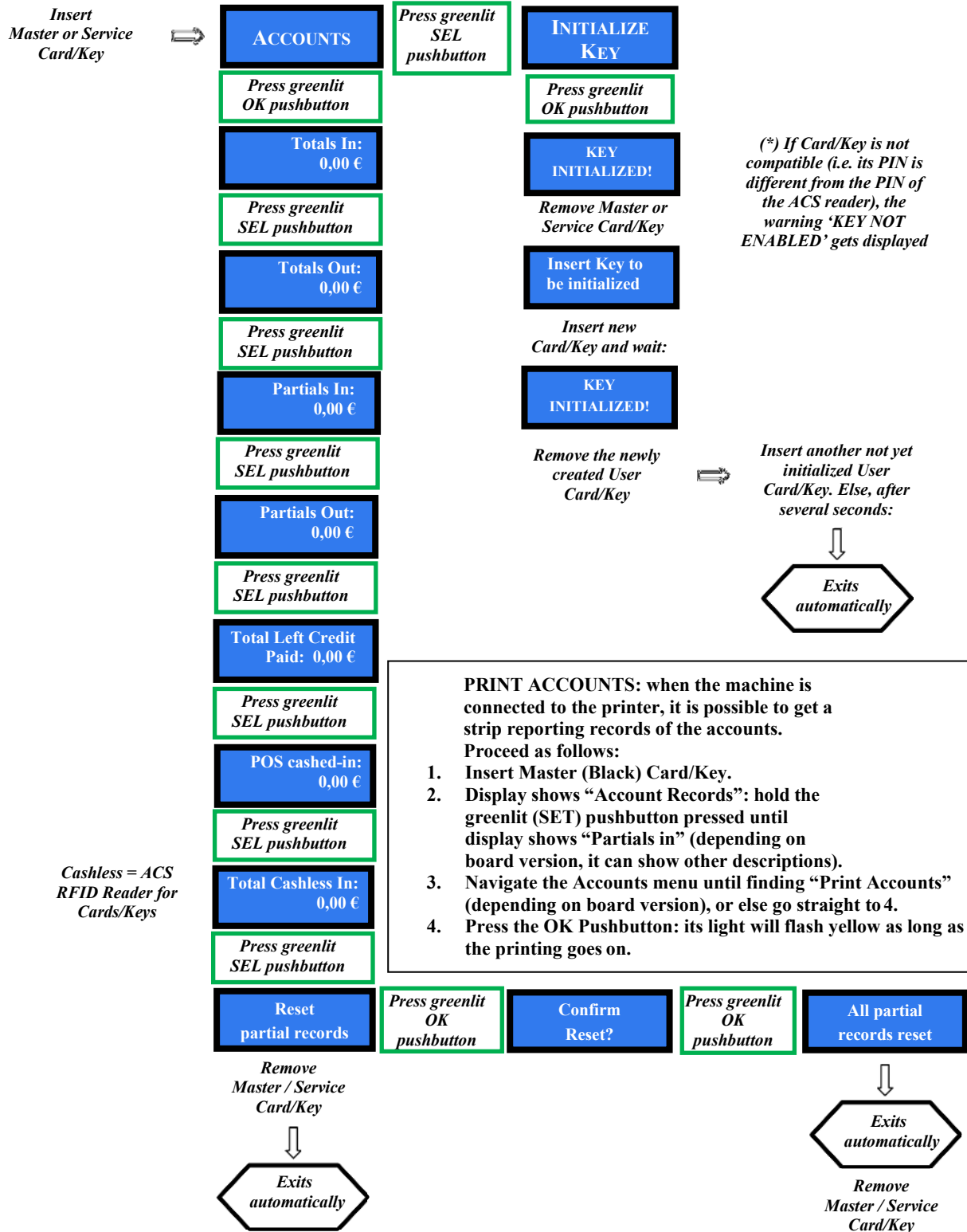

7. System configuration

7.1 Default setup

This Money-Change machine is preset by default as follows (unless requested for different setup):

Control Board Parameters

Pay-out mode = AUTOMATIC
 Bonus = DISABLED
 Level sensors = DISABLED

Hopper S11 Parameters

€ 2.00 = ENABLED

Hopper AH4 discriminator [ccTalk]

Preset by default to 0,50 – 1,00 – 2,00 € *Note*

Validator [ccTalk] Parameters

€ 5.00 - ... - € 100.00 = ENABLED *AL66 S*

[ccTalk] coin acceptor Parameters

€ 0.05 - € 0.10 - € 0.20 = DISABLED

€ 0.50 - € 1.00 - € 2.00 = ENABLED

Restore default configuration

If any unwanted variation is made, it will be possible to restore the default configuration as follows: enter the initial menu, scroll by UP and DOWN keys and choose *RESTORE DEFAULT CONFIGURATION* then press OK; the message *DEFAULT CONFIG. RESTORED* will be displayed.

NOTICE: the *RESTORE DEFAULT CONFIGURATION* command restores the default PIN code (0000) .

7.2 System connections

7.2.1 MODELS WITH SEPARATE POWER BOX AND HUB PCB

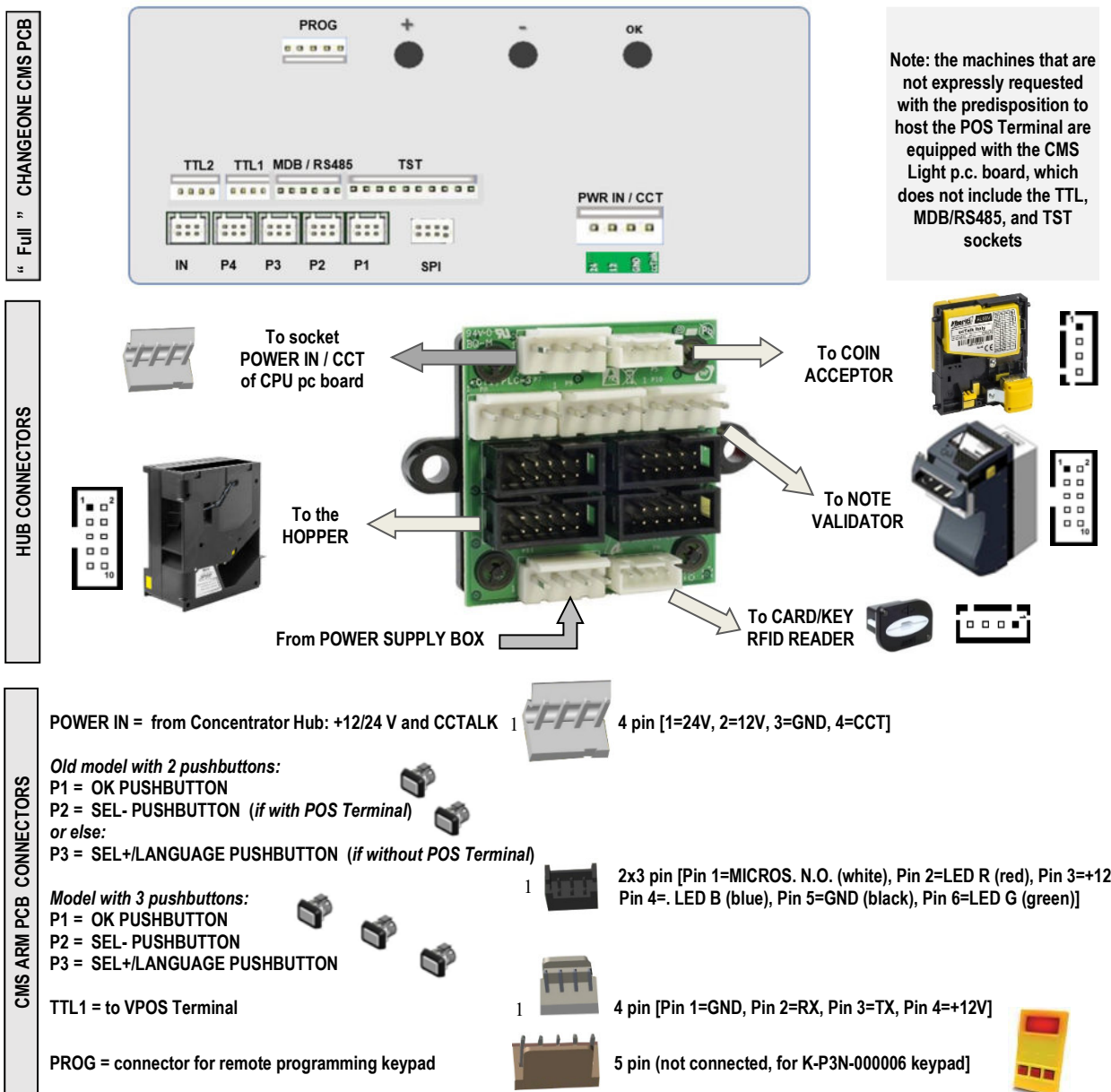

7.2.2 MODELS WITH MP1 POWER MODULE AND INTEGRATED HUB PCB

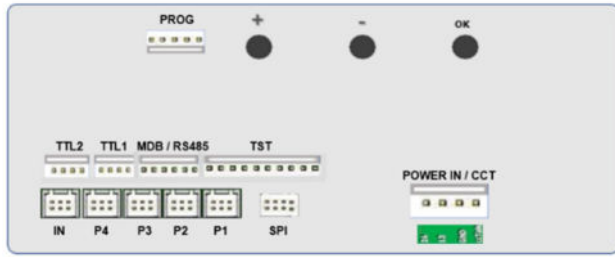

“ Full “ CHANGEONE CMS PCB

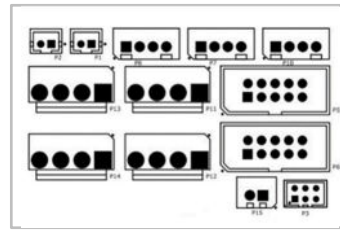

HUB PCB FOR CONNECTION OF THE PERIPHERAL UNITS



SOCKETS IN CHANGEONE CMS PCB

PWR IN/CCT = from the Hub pcb
(in the MP1 Power Module):
+24V / +12V / GND / CCTALK



| | | |
|------|---|---------------------|
| +24V | 1 | Pin 1 = green wire |
| +12V | 2 | Pin 2 = yellow wire |
| GND | 3 | Pin 3 = black wire |
| DATA | 4 | Pin 4 = white wire |

P1 = OK PUSHBUTTON



P2 = SEL- PUSHBUTTON



P3 = SEL+/LANGUAGE PUSHBUTTON



TTL1 = to the POS Terminal

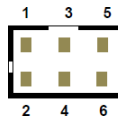

| | | |
|---------------|---|---------------------|
| Micro NO | 1 | Pin 1 = grey wire |
| LED R (Red) | 2 | Pin 2 = red wire |
| +12 V | 3 | Pin 3 = yellow wire |
| LED B (Blue) | 4 | Pin 4 = blue wire |
| GND | 5 | Pin 5 = black wire |
| LED G (Green) | 6 | Pin 6 = green wire |

PROG = socket for the optional K-P3N-000006
external programming keypad



5 pin (not connected)

SOCKETS IN HUB PCB (ON INTEGRATED MP1 POWER MODULE)

Power to the Hub pcb is provided directly by the MP1 Power Module

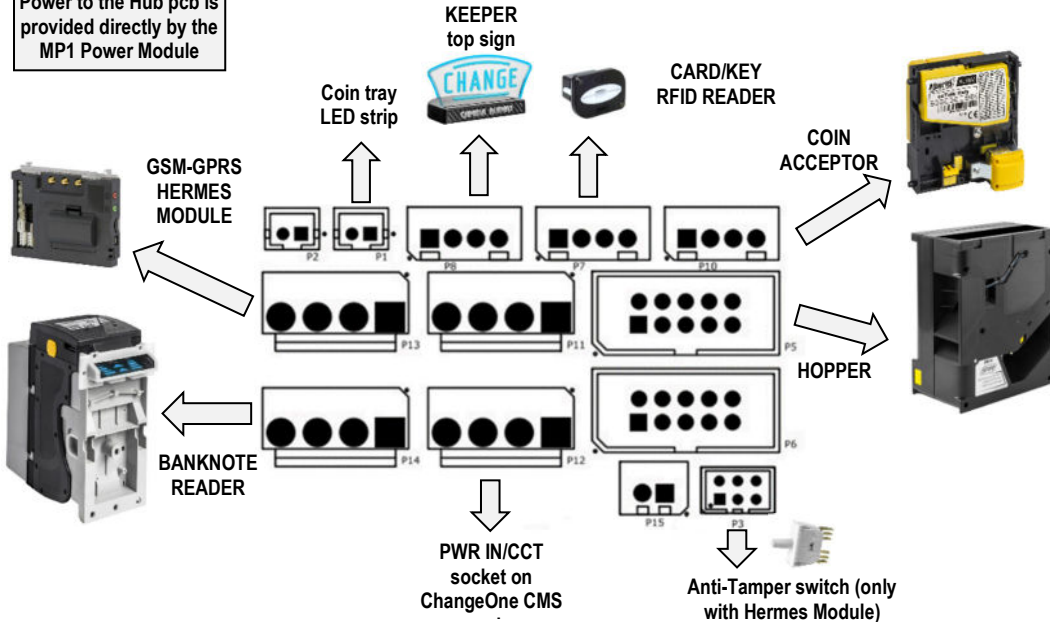

| | | | |
|------|---|----|------|
| DATA | 1 | 2 | VOID |
| VOID | 3 | 4 | GND |
| VOID | 5 | 6 | VOID |
| +24V | 7 | 8 | GND |
| VOID | 9 | 10 | +24V |



| | |
|----------|---|
| DATA | 1 |
| GND | 2 |
| NC | 3 |
| +12/24 V | 4 |



| | |
|------|---|
| +24V | 1 |
| +12V | 2 |
| GND | 3 |
| DATA | 4 |

7.2.3 INSTALLING THE POS TERMINAL:

Depending on the type of POS that the machine has been requested, the relevant interface with cable is provided among the accessories (find it inside the cashbox). Connect the 4p end of the POS Interface cable to the TTL1 socket of the main pcb:

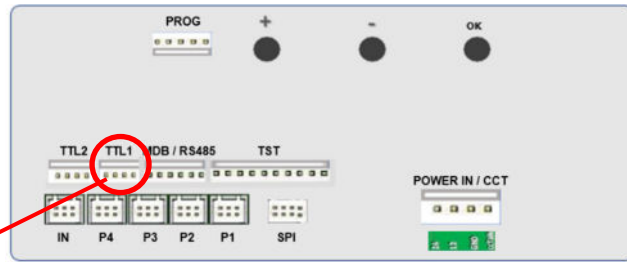

NAYAX 3G

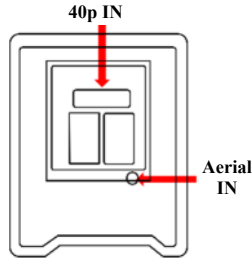

Connect the 40p end of the POS Interface cable and the aerial as indicated

NAYAX ONYX

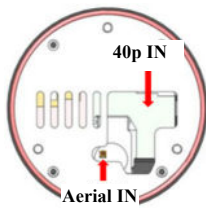

Connect the 40p end of the POS Interface cable and the aerial as indicated

WL VALINA

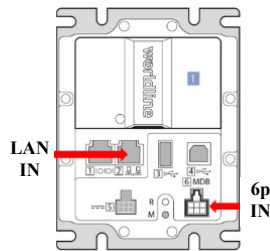

Connect the black 6p (MDB) end and the Ethernet connector (LAN) of the POS Interface cable as indicated.

PAYTER

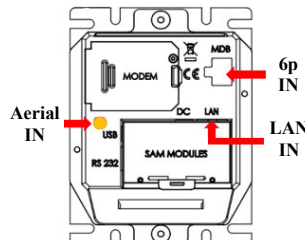

Connect the white 6p (MDB) end and the Ethernet connector (LAN) of the POS Interface cable as indicated.

INGENICO

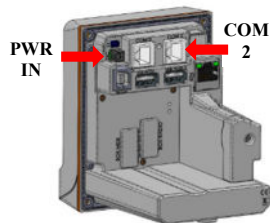

Connect the RJ11 plug of the interface cable to the POS COM 2 socket as indicated.

Connect the 2p plug (yellow and black wires) to the PWR socket of the POS terminal as indicated.

Start the Service Menu:

1. go to “Peripheral Units Setup” and confirm (see 7.2.1 and 7.2.5); go to “Set up Dispensing Mode” and confirm (see 7.2.5.C);
2. set to “TOKENS” and confirm; set values of Tokens in the Hopper;
3. set MODE to “AUTOMATIC” or to “MANUAL”; if AUTOMATIC has been chosen, enable and program the “Pay-out Table”; if desired, the “Pay-out Table” can be enabled also for MANUAL mode;
4. set hopper Level Sensors and confirm: the display will return to “Set up Dispensing Mode”;
5. go to “Enable/Disable POS”, and ENABLE POS;
6. select type: NAYAX, or VALINA, or PAYTER, or INGENICO, and confirm; then exit the Menu.

7.3 Menu functions

7.3.1 SURFING THE MENU:

To enter the menu and navigate it, keep pressed the 3 buttons behind the display for 5 seconds.

“OK”

confirm selection

“+” / “-“

navigate menu UP and DOWN; or, modify figures and letters

MENU MAIN STRUCTURE

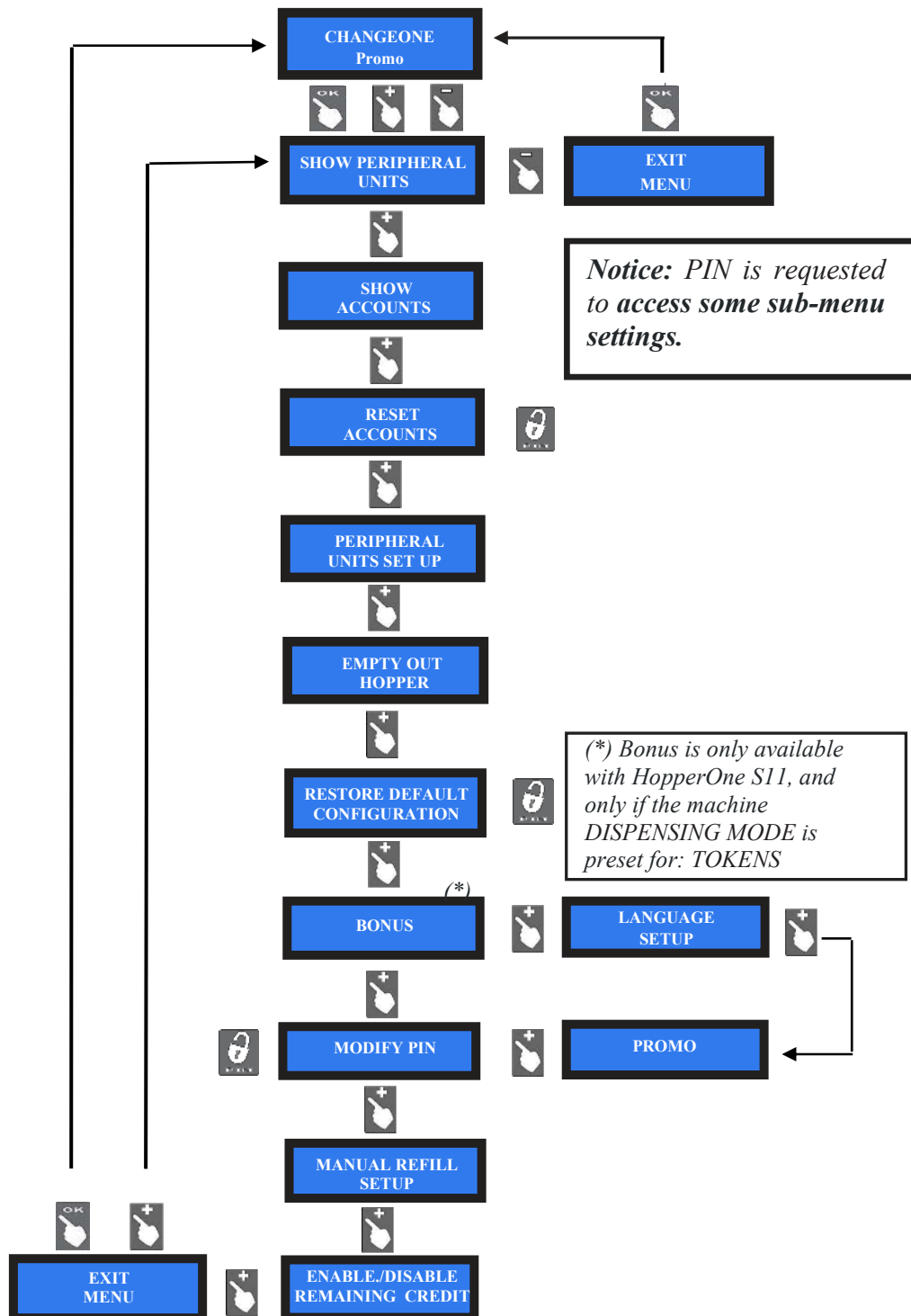

7.3.2 Show peripheral units

This menu allows checking the state of the PERIPHERAL UNITS, for instance:



7.3.3 Show accounts

This menu allows to check the total and the partial values of cashed and paid amounts.

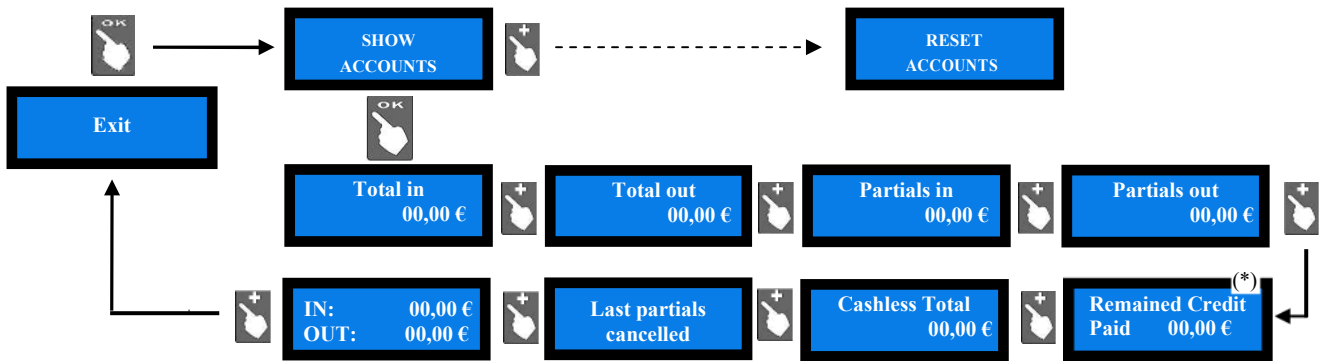

(*) *Reset of the remaining credit: see section 7.3.14*

- Press OK: the display will show the total amounts introduced (TOTAL IN). Press UP, and OK if you want to exit the ACCOUNTS menu.
- Or else, press DOWN to check the total amounts dispensed (TOTAL OUT).
- Press DOWN to go on browsing the submenu.

Notice: whenever the Partial Amounts records get cancelled (see section 7.3.5), the previous value recorded in "Last Partial cancelled" gets replaced by the amount that has just been reset.

LAST AMOUNT DISPENSED: *when the board is in stand-by condition, it is possible to check the last amount dispensed, by holding the SELECT pushbutton for full 4".*

7.3.4 Reset accounts

To use this sub-menu it is necessary to digit the PIN code. It allows to cancel the account records (both paid out and cashed in) in the machine. Once entered the PIN, the display will show:

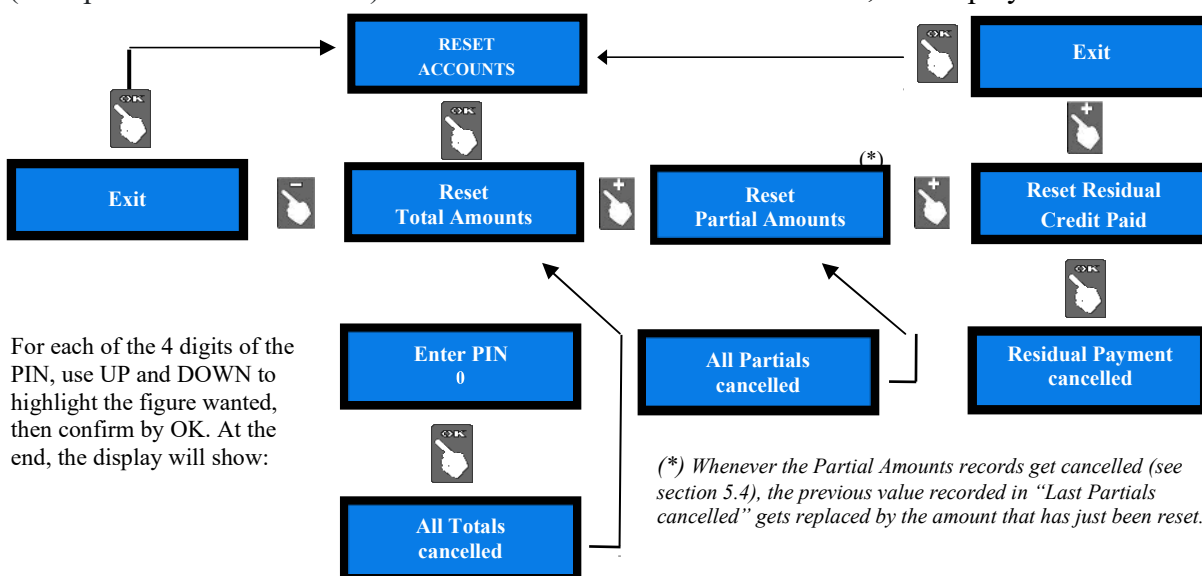

For each of the 4 digits of the PIN, use UP and DOWN to highlight the figure wanted, then confirm by OK. At the end, the display will show:

(*) *Whenever the Partial Amounts records get cancelled (see section 5.4), the previous value recorded in "Last Partial cancelled" gets replaced by the amount that has just been reset.*

PLEASE NOTE: when re-configuring the unit from token dispenser to coins dispenser, always activate **RESTORE DEFAULT CONFIGURATION** and then **RESET ACCOUNT RECORDS**.
If not done, memory of the bonus given would distort the audits.

7.3.5 Setting up the peripheral units and the POS terminal

This menu allows to set up the denominations accepted by the note validator and by the coin acceptor, as well as the value of the coins/tokens dispensed. It also permits to set the change mode as either automatic or manual, and to enable/disable the full/void sensors of the hoppers.

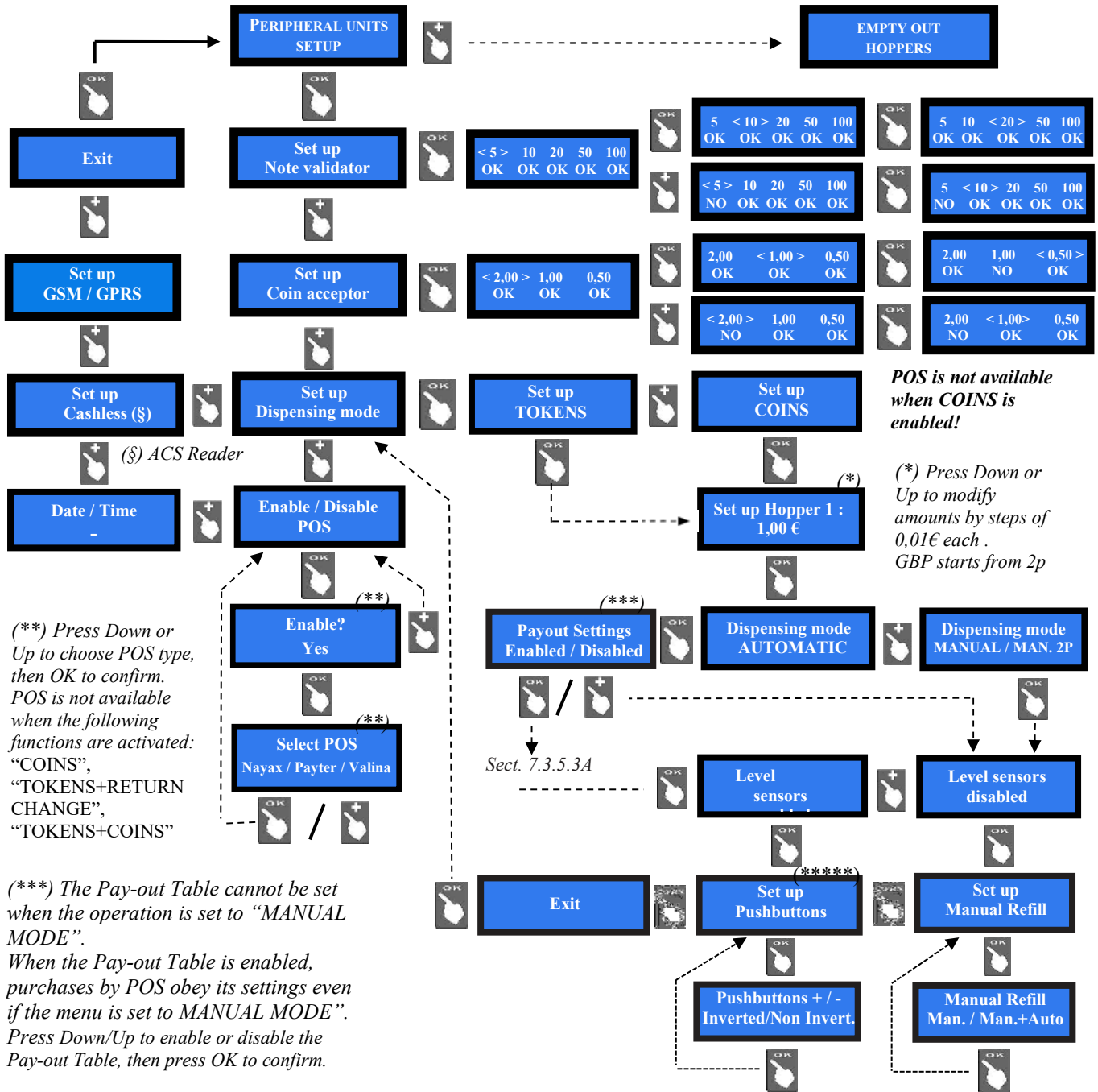

| Single-coin hopper, menu set to dispense TOKENS | |
|---|--|
| POS | Enable/disable option available, POS terminal functioning |
| Pay-out Table | Available after choosing the Automatic Dispensing Mode in the Menu |

| Single-coin hopper, menu set to dispense COINS | | Multi-coin hopper, menu set to dispense COINS | |
|--|---|---|---|
| POS | Enable/disable option not available, no POS | POS | Enable/disable option not available, no POS |
| Pay-out Table | Available in the Menu for Change functions | Pay-out Table | Not available in the Menu |

7.3.5.1 NOTE VALIDATOR SETUP

All the programmed note values get automatically enabled at power-on. To modify acceptance, press OK to get to the first option (ex. 5 €) and highlight it, then press UP or DOWN to reverse its state. Press OK to shift to the next option (ex. 10 €).

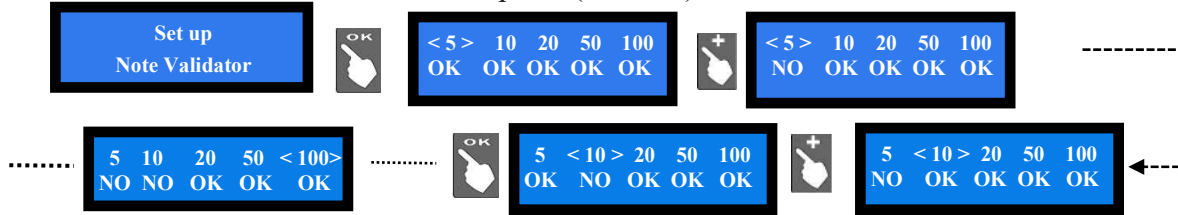

7.3.5.2 COIN SELECTOR SETUP

The board automatically detects the presence of the coin selector during initial check. Among the accepted coins (0.05-to-2 €), the following ones get enabled by default: 0.50 € - 1.00 € - 2.00 €. To modify this condition, press OK to get to the first option (ex. 2 €) and highlight it, then press UP or DOWN to reverse its state. Press OK to shift to the next option (ex. 1 €).

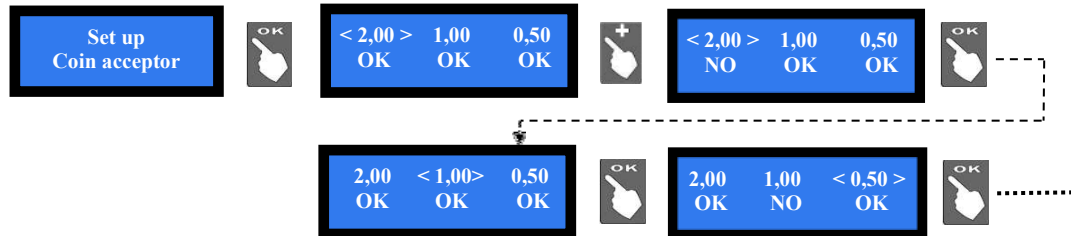

7.3.5.3 DISPENSING MODE AND POS SETUP

Allows to choose to dispense COINS or TOKENS or TOKENS+CHANGE or TOKENS+COINS, and if DISPENSING MODE must be AUTOMATIC or MANUAL. Also permits to control the level of the coins in the hopper by optic sensors, and to set the desired POS terminal.

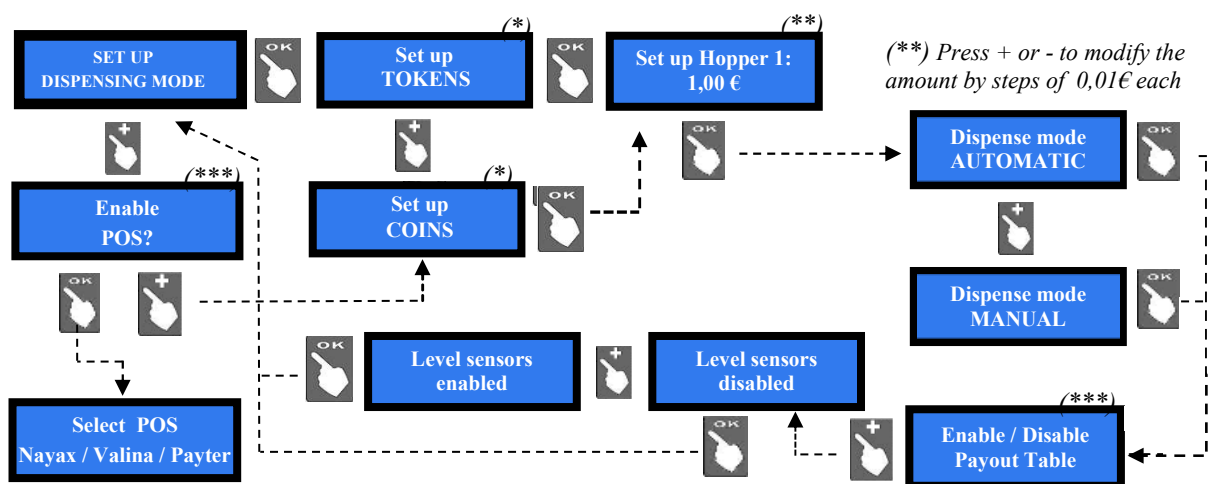

(*) **Enabling COINS option will make POS option unavailable!**

(***) Press + or - to select the POS type, then OK to confirm.

(**) Press + or - to modify the amount by steps of 0,01€ each

see Section 7.3.5.A to set up the Pay-out table

NOTICE: monitoring of level sensors is disabled by default. This means that the board does not know when the hopper is empty, so it will send the pay-out command even if there are no coins available. When the hopper runs out of coins during dispensing or at the end of payment, no warning will be displayed. If the empty state is detected when powering the unit, this one shall not accept any money.

If the monitoring has been enabled, and there are not enough coins in the hopper, the display will warn that the hopper is empty, even though there are always about 20 coins available, so as to complete large change payout.

7.3.5.3 A PAY-OUT TABLE SETTINGS: if and only if machine is set up for dispensing **only Tokens**, it will be possible to enable the Pay-out Table or to disable it. To enable the settings, press the OK button. Nine (9) value levels are available. In the example below, tokens in hopper are set to 1€, and User will be allowed to buy only by amounts of 1, 2, 5, 10€, with bonus at 5 and 10 €.



Enable the Pay-out Table for the POS in the AUTOMATIC Mode, even if the Manual Mode will be used.

WARNING! If the machine must be re-configured from Tokens (or Tokens + returned change) to coin, always reset to DEFAULT CONFIGURATION and cancel ACCOUNTS. Else, bonus logs will produce Accounts inconsistency.

7.3.5.4 SET UP CASHLESS (only if the ACS reader is built-in)

If the unit is equipped with the ACS reader, it is possible to get access to useful functions:

| Operation | Master Card/Key (black) for the Owner | Service Card/Key (white) for the Manager |
|---|--|---|
| 1. Initialize RFID Card/Keys | YES | YES (no Master Card/Key) |
| 2. Enable white key to collect money | YES (from Menu) | NO |
| 3. Check Accounts (totals and partials) | YES | YES (partials only) |
| 4. Print Accounts | YES | NO |
| 5. Reset Accounts Data | YES | YES (partials only) |
| 6. Reset of paid residual credit | YES | YES |
| 7. Access to (optional) manual Refill | YES | YES |

Once created, the Master Card/Key allows to initialize User Cards/Keys on the ACS reader.

Whenever the Master Card/Key or the Service Card/Key gets access to the Accounts menu, the shown data get automatically downloaded in the Card/Key. Each Card/Key can contain up to 10 downloaded sets. These data sets can be read and filed to PC via the ACR Programming Station (K-P4N-000007) and sw. The ACR Programming Station can be used also to load credits on User Cards/Keys. 

Credits can be loaded on the User keys by the Key Loader One (TB-L6A2) device as well. 

Before initializing the ACS RFID reader and the Cards/Keys, the owner of the Owner/Master key (black colour key) must:

- i. establish an initialization code (PIN) with 6 alphanumeric characters, write it down and keep it in a safe place, to re-use it (if necessary) later;
- ii. create and enter the machine's 4-digit PIN code (see section 9.3.13 Change PIN Code), write it down and keep it in a safe place.

All the Cards / Keys initialized on the devices that share the same PIN as the machine's PIN will be matched automatically to this machine. Therefore, they can be used only and on all such devices sharing the same PIN, while the Cards / Keys associated to other PINs will not be recognized as compatible. Depending on whether the PIN remains the default one (0000), or whether it is set with a different combination (e.g. 1234), there will be two operation modes:

- i. Machine PIN = 0000 > all Cards / Keys will have access to the services offered by the machine.
- ii. Machine PIN = (e.g.) 1234 > only the Cards / Keys programmed by the Owner with code 1234 will have access to the services offered by the machine(s) with code 1234.

Even when Cards / Keys are initialized with the ACR Programming Station (K-P4N-000007), the PIN of the machine on which these Cards / Keys must be used must be memorized in each of them.

7.3.5.4a Initializing the ACS RFID Reader (Antenna) and the Master/Owner and Service/Manager Cards/Keys

When accessing this submenu for the first time, the display prompts the Operator to initialize the Cashless ACS reader: confirm by the “OK” key. The display will request to enter the 6-digit password PIN. Select the first digit using the “+” and “-“, and confirm it with “OK”. Repeat the operation for each of the next 5 digits.

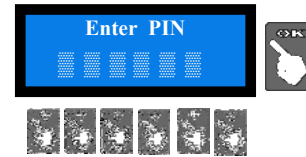

The display will now ask to confirm the entered 6-digit code; insert it again: the initialization of the ACS Cashless reader will then be started. At the end, the display will confirm that the ACS reader is ready, and will return to the configuration menu.



It is possible now to initialize the Master/Owner card/key, necessary to create User card/keys. Please notice the following:

-  Master and Manager Cards can only be created using Chip Cards CH-2N01.
- User Cards can only be created from Standard Cards CH-2N02 or CH-2N03.
- Any type of Keys can only be created using Alberici branded keys: CH-1C11 - CH-1C16.

Insert the Master Card/Key in the initialized ACS RFID Reader: the machine 4-digit pin code (see section 9.3.13) will be requested; enter it to get the Master Card/Key initialized. Do not remove the Card/Key during the initialization process, until the confirmation that the Card / Key has been initialized gets displayed. Now the initialized Card/Key can be drawn out.



By the same process, the Service/Manager Card/Key can be initialized.

User Cards/Keys must be initialized by a different process:

- i. quit the Set-up Menu;
- ii. insert the Master Card/Key in the ACS Reader: the SEL and the OK pushbuttons will light up in green colour, and the display will show “ACCOUNTS”;
- iii. touch the green lit SEL button, to display “INITIALIZE KEYS”, then
- iv. press the green lit OK pushbutton: the display will show “KEY INITIALIZED!”.
- v. Remove the Master/Owner Card/Key;
- vi. insert the Card/Key that must be initialized as User Key, then
- vii. wait until the display shows “KEY INITIALIZED!”:

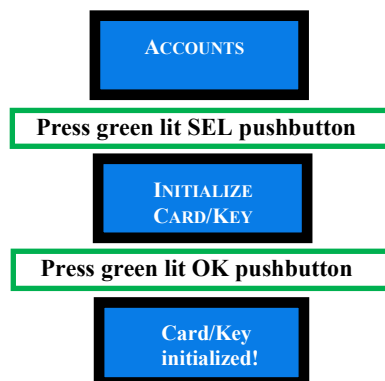

Remove the Master / Service Card or Key. The display will now prompt to insert then User Card/Key that must be initialized:



 To load credit on the User Cards/Keys, see section 6.4.2.

7.3.5.5 SET UP GSM/GPRS

When the GSM/GPRS kit is installed, it gets detected during self-configuration, and its parameters must be set up for operation. SMS functions will not be working on Hermes GPS/GSM module; remote control will then be managed only through the Argo Portal or through the Argo App.

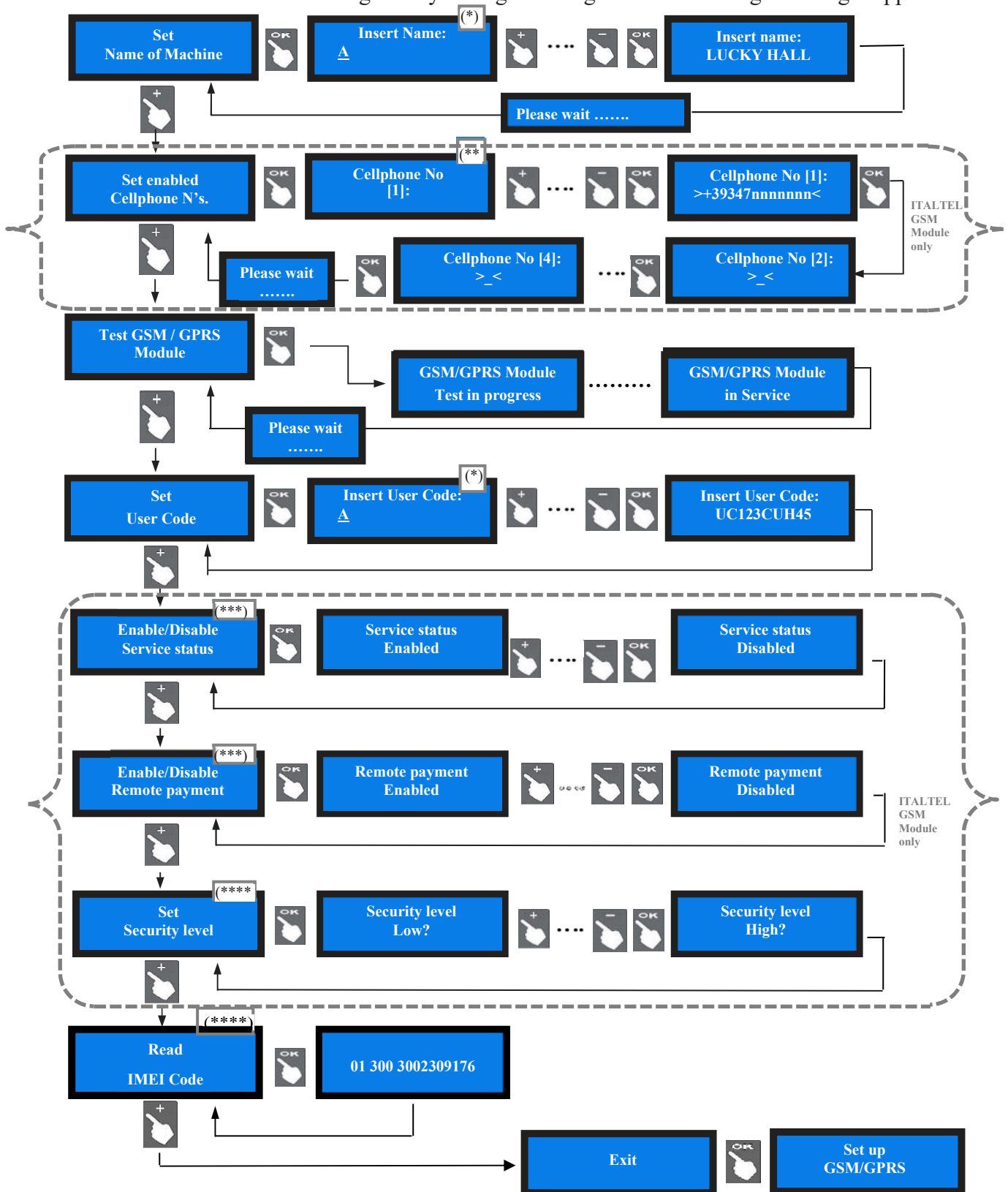

(*) By the + and - buttons, locate the letter/digit, and press the OK button to confirm your choice; the cursor will automatically move to the next character. There are 16 characters in the machine name, and 10 in the User Code. After having confirmed the last character, the name or the /code you have typed gets automatically saved. In case you have purchased your subscription(s) when buying the machine (or the Hermes GSM module), no need to enter the User Code; it will be already present in the menu.

(**) This function is available only in special versions (old GSM modules). By buttons + and - , locate the number you want to write, and press OK to confirm it; the cursor will automatically move to the next character. Once confirming the last digit, also confirm the whole number entered: it is proposed to enter the second number, and finally the third.

(***) When the Service Status function is enabled, the machine can be put out of service by the relevant button in the ARGO Portal dashboard. Service can be restored by left-clicking on the same button.

(****) When the Remote Payment function is active, and the Security Level has been set to **Low**, it is possible to command the machine to dispense an amount (in €) or a number of tokens (pieces) by the relevant command button in the ARGO Portal dashboard. When the Remote Payment function is active, and the Security Level has been set to **High**, it is possible to command the machine to dispense an amount (in €) or a number of tokens (pieces) by the relevant command button in the ARGO Portal dashboard. In this case, the display will prompt the User to enter the password: the User will then put his Refill key in the Refill lock (or his RFID key in its Reader), and then enter the password by the buttons SEL (select each number) and OK (confirm each number)

7.3.6 Empty out the Hoppers

Use this function to make the selected hopper pay out all the contained coins / tokens. Once emptied the first hopper, total dispensed amount shall be displayed. Press OK to go on with second hopper.

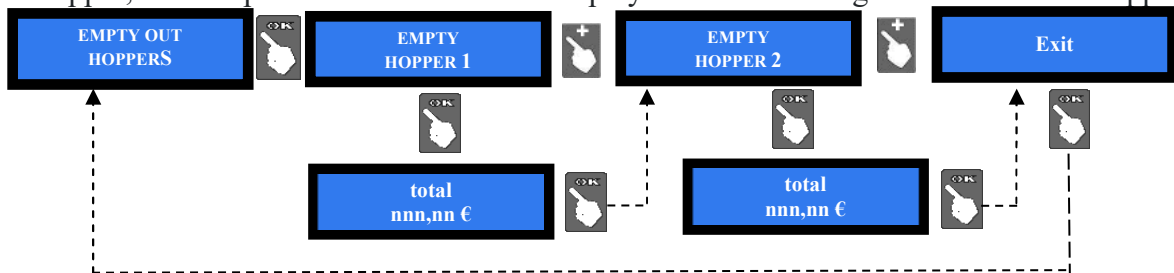

7.3.7 Restore to default configuration



To use this sub-menu, it is necessary to digit the PIN code.

WARNING: the system sets back to default configuration. The PIN code will be reset to the default 0000 setting. Account records shall not be cancelled.

7.3.8 Bonus Set Up (available only in Manual Mode, for purchase by Cash only)

This function will operate only if the hopper is preset for paying tokens, and the Pay-out Table (see 7.3.8.1) is not enabled. Bonus function is disabled by default.

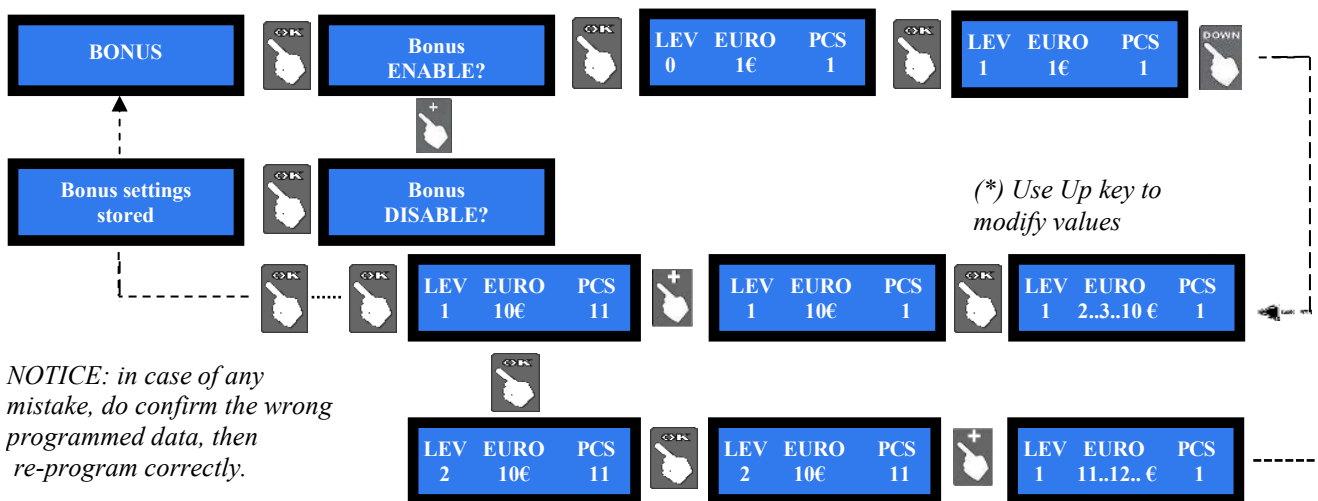

(* Use Up key to modify values

NOTICE: in case of any mistake, do confirm the wrong programmed data, then re-program correctly.



This sub-menu is not available when the Pay-out Table is enabled: however, it is possible to set the total number of tokens to be dispensed by entering it directly in the Table. Therefore, to disburse Bonus in Manual Mode, set this menu for purchase by Cash, and the "Payment Table"(sect. 7.2.5.B.i) for purchase by POS. to deliver Bonus, the POS follows only the Pay-out Table setting.

If credit accumulation (to reach bonus level) is necessary, please set the Dispensing Mode to **MANUAL**.

7.3.8.1 Bonus for POS payments: if the firmware of the machine includes the Pay-Out Table option, by which the amount of tokens delivered for different levels of POS paid money can be set, the display will allow the User to choose and purchase only among the preset payment levels. See setting flow-chart in section 7.3.5.3 **DISPENSING MODE SETUP**.

Pay attention: when purchasing by POS, the Pay-out Table will work as if Automatic Mode is set, even when Manual Mode has been set!

7.3.9 Language setup



When in stand-by, by pressing the “flags” button, the User can choose in which language the messages will be displayed (courtesy languages). The default language gets restored after one minute of machine inactivity. Using the Babel Software, it is possible to load message texts translated into the local language, as well as to set the local currency, into the menu. The language thus entered shall therefore appear among those selectable by default and among those of courtesy. In this regard, check the Babel Software Manual available on the www.alberici.net website.

7.3.10 Advert message

It is possible to preset an advertisement on the display. When prompted by:



press OK, the pointer will highlight the first digit: by UP or DOWN, choose the character that you want to insert, then confirm by OK. The pointer will highlight the following digit. Once digit no. 16 has been confirmed, the message gets stored.

7.3.11 Modify PIN

The PIN code allows to get access to the discretionary menus of the system. The PIN code is made up by 4 figures (each of them from 0 to 9: 10,000 combinations available).

ATTENTION: the default PIN code is 0000

The settings in the following menu can be modified by using the PIN code:

MODIFY PIN - RESET ACCOUNTS - RESTORE DEFAULT CONFIGURATION

To modify the existing PIN, press OK, and digit the old PIN code: to digit each code figure, first use keys UP and DOWN to set each figure, then confirm it by OK. Once the 4th figure has been confirmed, confirm by OK the whole old PIN:

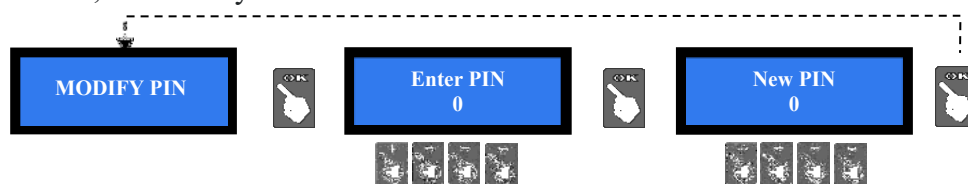

To enter the new PIN code, use first the UP and DOWN keys to set each figure, then confirm it by OK. Once the 4th figure has been confirmed, confirm by OK the whole new PIN. As every single figure gets confirmed, an asterisk takes its place, so preserving secrecy.

NOTICE: when DEFAULT CONFIGURATION is restored, the PIN code gets reset to 0000.

If the entered PIN is not correct, the User is given another 4 tries before the board gets blocked-up by its security interlock. Before the 5th error, the system can be started again by switching it off and on again. After the 5th error, the machine will be blocked, while the display will show two codes. Please send such codes to Alberici Assistance, to get the reset information.

7.3.12 Manual Refill Set Up (not available in all units)

Carrying out the Manual Refill allows the Accounts records to keep track of the actual amounts available in the dispensers. It allows as well to warn when such amount becomes less than the reserve threshold level; in such event, the OK button starts flashing yellow until the hopper gets refilled. Refill can be made when the unit is empty or still containing more than the preset reserve amount.

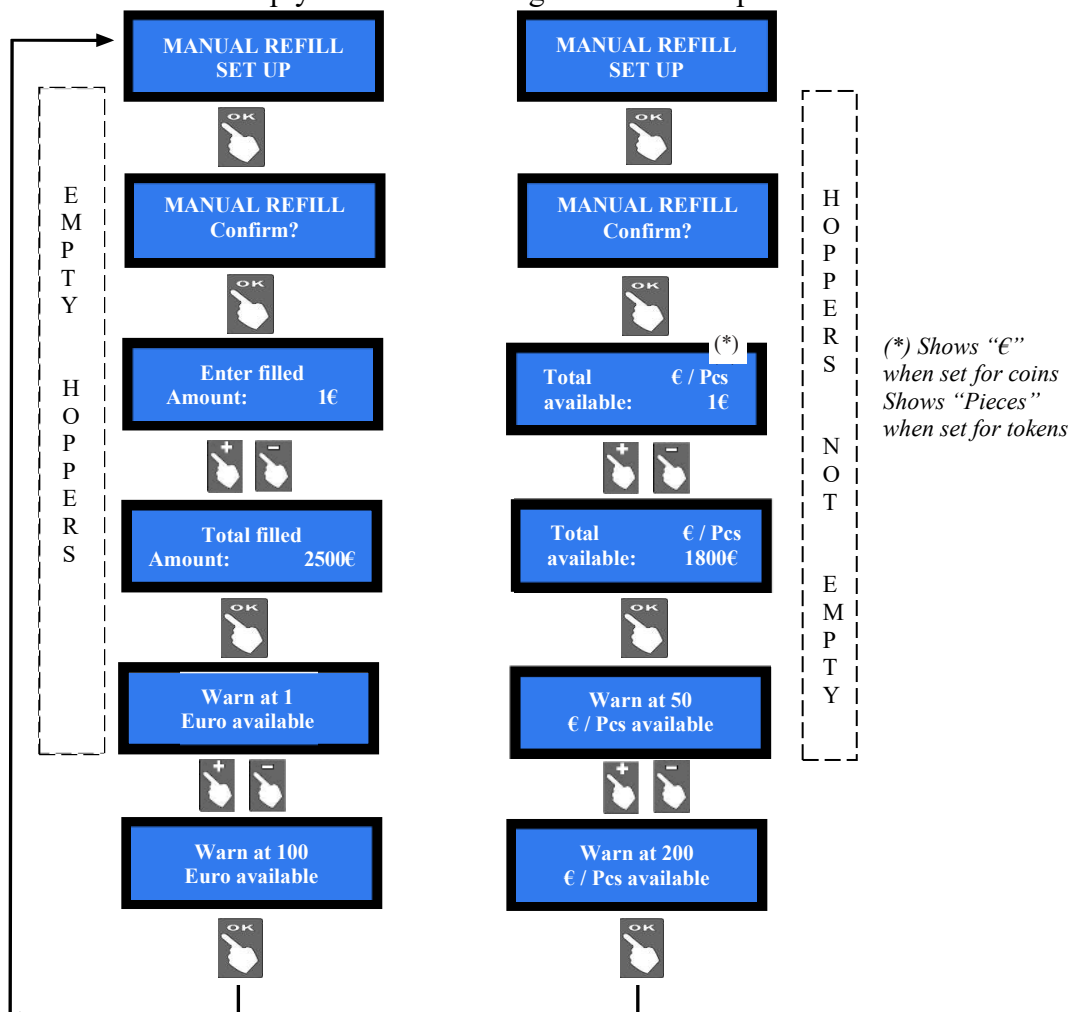

7.3.13 Enable / Disable remaining Credit

Amount of remaining (i.e. unpaid) credit can be reset when machine is switched off. Such amount gets automatically recorded in the Accounts (section 7.3.4).

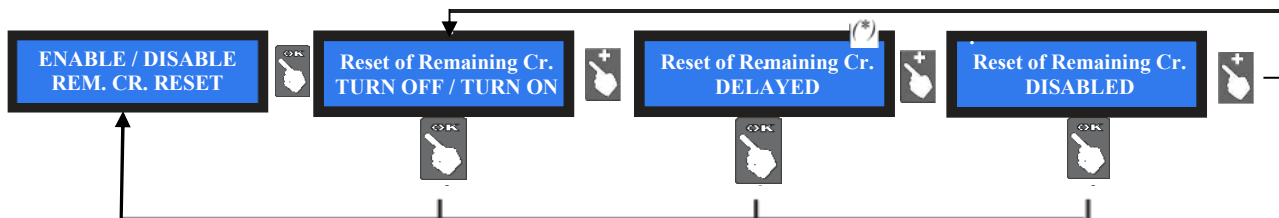

(*) When enabling this option, the remaining credit shall be cancelled within 15 seconds from end of transaction.

7.3.14 Exit Menu

Press OK to go back to stand-by condition:



8. Messages

Display contrast

Should the contrast between the characters and the background be not convenient, adjust it as follows:

- disconnect the cable from socket POWER IN/CCT of the pcb, and power up the machine;
- hold down the “+” and “-“ buttons of the pcb at the same time, and plug the cable into socket POWER IN/CCT; when the display starts flashing, release both buttons;
- a prompt (in Italian language) will propose you to set the desired contrast level;
- press the “+” button to increase the intensity of contrast/brightness. Intensity can be adjusted between -15 and + 15. Standard values range between -1 and +5
- once the desired degree of illumination has been reached, press the “ok” button;
- power off the machine, then power it on again.

8.1 Messages on the display

8.1.1 Faulty operation:

The following warning:

CHANGEONE
OUT OF SERVICE

is accompanied by the system check. For instance, the following sliding warnings:

...COIN ACCEPTOR...
.. DISCONNECTED ...

PTOR.....NOT
CTED.....IN ER

TOR... HOPPE
ROR EMPT

R N° 1... HOPPE
TED DISC

stand for:

the coin acceptor is not connected; there is a fault in the note validator; hopper 1 is empty; ...

The following error messages can possibly appear:

(PERIPH. UNIT)
CONNECTED

the mentioned peripheral unit (coin acceptor, or note validator, or Hopper, and so on) is connected and functioning

(PERIPH. UNIT)
DISCONNECTED

the mentioned peripheral unit has been disconnected

(PERIPH. UNIT)
IN ERROR

the mentioned peripheral unit is connected but faulty

HOPPER
EMPTY

the Hopper is empty

BANKNOTE
DISABLED

the inserted note is not enabled

The message

Remaining Credit
1 €

means that coins have run out during the payout. Switch power off, fill the hopper up, and switch power on again: the board will prompt the hopper to complete the payout.

8.2 Code RI (blocked CPU)

If this message appears, at startup or during operation, press the three buttons (OK, UP and DOWN) on the board simultaneously for at least 5 seconds.

This operation restores the default values: it will therefore be necessary to reconfigure the system as before. If the RI code is displayed again after carrying out this operation, it means that the EPROM is out of order. It will therefore be necessary to replace the board.

8.2 Messages from the Note validator

8.2.1 BillyOne / OryOne Validator

During operation, the amount of consecutive red flashes produced by the entry slot indicates the possible malfunctions (see chart below):

| no of red flashes | Description |
|-------------------|---|
| 1 | Validator is open |
| 2 | Jammed banknote |
| 3 | Fraud attempt detected |
| 5 | Adjust optic sensors |
| 7 | Stacker full (OryOne Only) |
| 9 | Low power supply |
| 11 | Check operation of the encoder + efficiency of the validator motor |
| 12 | Check operation of the encoder + efficiency of the stacker motor (OryOne) |
| 14 | ROM error |

8.2.2 Inlet bezel colour warnings

Two repeating blue blinking: the stacker has been removed, or its detection sensor is faulty.

Regular blue blinking: dip-switch 1 is to OFF position (Pulse mode).

Solid yellow: ccTalk communication error. Check voltage level (12 and 24Vdc). Power off and on. The vv. 2.17+ of the CMS pcb restore communication when the voltage goes back to normal.

8.2.3 Fraud-fishing protection

The banknote reader is equipped with a security device that gets activated in the event of fishing fraud attempts repeated through a period of time.

This device can be set through the dip-switch SW8 (DS-row on the Validator side) to operate in a "soft" mode (* DS8 = ON) or in "extended" mode (** DS8 = OFF).

(*) Dip-Switch SW8 ON

Any attempt at "fishing" will cause the note to be rejected, without showing any signal.

(**) Dip-Switch SW8
OFF

| Attempt | Validator reaction | Do as described below |
|---------|-------------------------|----------------------------|
| 1st | Remains in service | - |
| 2nd | Remains in service | - |
| 3rd | > error (3 red flashes) | Reset (switch off then on) |
| 4th | > error (3 red flashes) | Reset (switch off then on) |

After the 5th fraud attempt (3 yellow flashes), it is necessary to wait for automatic restore of service. Take care not to switch the device off.

8.3 Code RI (RI Code) - (CPU in Control Board is blocked)

The 'Code RI' message means that there has been an event that makes it wise to hold the EPROM from operating. If and when it pops up, hold down the 3 OK, UP e DOWN keys at the same time for 5 seconds.

Such operation will reset the machine to its default configuration. It will then be necessary to re-program the machine settings according to the needs.

In case that the 'Code RI' message pops up again after releasing the 3 keys, it means that the EPROM has been damaged: it will be necessary to replace the board.

9. Cleaning the Note Validator



WARNING! Do switch power off before opening the machine!

9.1 Manual cleaning

The ability of acceptance may decrease due to the accumulation of dust and cellulose dust released by banknotes during transit, or because of residues or sprays, which may spread on the detecting sensors and on transmission parts.

It is therefore recommended to **clean these parts at least monthly**, as indicated below.

1. Turn power off and unplug the cable from the 10-pin connector interface. Press the yellow button C, located under the reader, to release the main body from the faceplate, and slide it backwards.

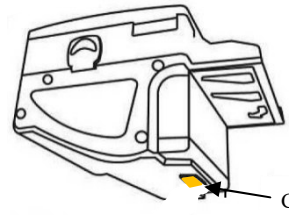

2. Move the D button upward, hold it while sliding the cover backwards; then lift the latter up and rotate it 180° to the right side.

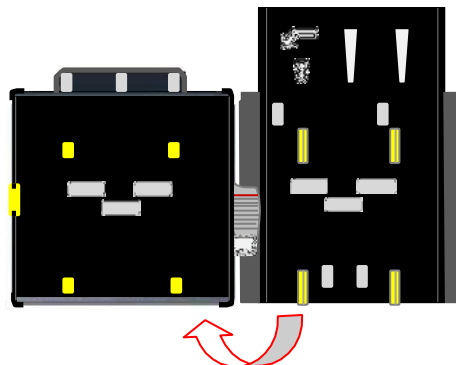
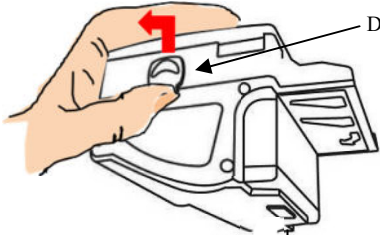

3. Gently wipe the sensors with a clean, lint-free tissue, or with a cotton swab, or with a small sponge, possibly moistened with isopropyl alcohol.
4. Completely remove the dust and residues from the 4 silicone rollers, and from the 4 elastic matching wheels which are located in the lower surface of the upper lid. To remove the most stubborn dirt from rollers and wheels, use *isopropyl alcohol*.

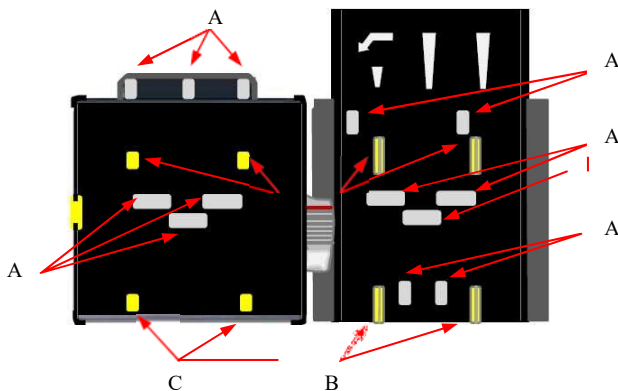

PAY ATTENTION: *do not use organic detergents (ex. alcohol, thinners or petrol). Use only isopropyl alcohol.*

1. Sensors
2. Rollers
3. Elastic matching wheels

9.2 Clearing jammed banknotes

CAUTION! Turn off power before opening its upper lid.

Open the top cover by pressing D and pull out the stuck banknote (as well as any other objects that will hinder the transit).

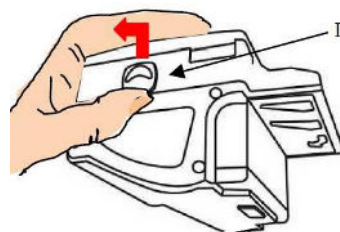

10. Disposal of the product

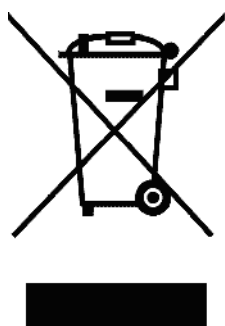

WARNING! DISPOSE OF ACCORDING TO THE GOVERNING LAW IN YOUR COUNTRY!

This equipment may not be treated as household waste. Instead, it must be handed over to the applicable collection point for the recycling of electric and electronic equipment. By ensuring that this product is disposed of correctly, you will help to prevent potential negative consequences for the environment and human health, which could otherwise be caused by inappropriate waste handling of this product.

For more detailed information about recycling of this product, please contact the Dealer where you purchased this product.

11. Terms of Guarantee

The manufacturer will fix malfunctions arising from production faults in this machine or parts of it within 12 months from the date of sale.

All communications referring to guarantee repairs or replacements must be accompanied by the product serial number and the copy of the sale invoice.

To obtain your guarantee repair, please send the part to the Dealer where you purchased the machine, together with the following documents:

- copy of the sale invoice
- delivery note stating "returned for guarantee repair"
- detailed report of the problem found and the circumstances in which it occurs.

Before sending the product, please get in touch with your Dealer or with Alberici S.p.a. (+39 051 944300); very malfunctions can be fixed via a simple phone call, saving you costs and time.

Alberici S.p.a. will verify that warranty is applicable, i.e. that problem is not caused by:

- transport damages
- damages from incorrect installation or wrong configuration
- installation in premises or areas not complying with the prescribed safety requirements
- intentional or unwilling tampering
- wrong or careless use or maintenance
- non-compliance with precautions prescribed (see Chapter 4. Caution)
- natural disasters, vandalisms, intentional or unintentional damage

Guarantee is considered automatically expired if outer and inner labels are missing.

Transport costs of repaired products are at the Customer's charge.

12. Customer Service

Alberici S.p.a. will be pleased to offer all the necessary information on use, ordinary maintenance and technical service. Please call (+39) 051 944300 and specify if your request concerns information on use or technical support.

ATTACHMENT: Spare parts List

| REF. | OPT. | COD. | DESCRIZIONE | DESCRIPTION |
|------|------|--------------|---|---|
| 1 | | HR1-001A-V06 | Assemblato mobile (senza unità periferiche) | Unit core assembly (w/o Per. units) |
| 2 | | HR1-006A-V08 | Assemblato sportello (con serratura) | Hira door (includes lock) |
| 3 | | HR1-005A-V06 | Barra di chiusura | Anti-intrusion steel bar |
| 4 | | P-AM0702-10T | Portatarga P3 | P3 plexy plate |
| 5 | 5a | HR1-019A-I00 | Piastra chiusura foro gettoniera elettronica | Cut-out closure plate |
| | 5b | HR1-020A-I00 | Piastra supporto gettoniera elettronica | Coin acceptor support plate |
| 6 | | AM-1509 | Serratura sicurezza Flat Key sportello | Safety lock (Flat Key) |
| 7 | | S-030169-020 | Cablaggio generale Hira 1 | Hira wire harness |
| 8 | 8a | A-CM0241 | Assemblato alimentatore con cavo (include alimentatore) | RD-125 Power box with bracket |
| | 8b | AE-0806 | Alimentatore RD-125 | RD-125 Power box |
| 9 | | IM-N000-0L10 | Introduzione moneta PP | PP inner bracket for coin acceptor |
| 10 | | GE-66SU | Gettoniera elettronica AL66 S ccTalk mod. | AL66 S mod. ccTalk coin acceptor |
| 11 | 11a | HR1-CS01-Z00 | Cassetta moneta Hira per gettoniera | Metal coin box |
| | 11b | AM-1305 | Cassetta monete tipo "A" | Coin box "A" |
| 12 | | SH-1A21 | Scheda elettronica CMS (display blu 2x16) | CMS electronic control board (2x16 blue display) |
| 13 | 13a | LB-LU01 | Lettore banconote BillyOne UN1 | BillyOne UN1 note validator |
| | 13b | LB-MU02 | Lettore banconote OryOne UN1 | OryOne UN1 note validator |
| 14 | 14a | K-02C-020003 | HopperOne S11 ccTalk con schedino 10p | HopperOne S11 ccTalk + 10p adaptor |
| | 14b | K-02C-040016 | Hopper AH4 Discriminator II ccTalk con schedino 10p | Hopper AH4 Discriminator II ccTalk + 10p adaptor |
| 15 | | AA-0309 | Sector 100 1B/2C prolunga per Hopper | Sector 100 1B/2C capacity extension |
| 16 | | S-030212-000 | Cablaggio estensione per Sens. Ott. Liv. Max | Full level cable for capacity extension |
| 17 | | PL-MK21-ET60 | Puls. lum. miniatura Halo 21 (senza portamico) | Illuminated push-button Halo miniature 21 (no light core) |
| 18 | | PM-M186 | Portamico elettronico L.E.D. RGB 12V | RGB L.E.D. Mini electronic socket |
| 19 | | AA-0101-0600 | Piedistallo | Free-standing support |
| 20 | | TL-46S1 | Testatina luminosa Keeper | Keeper illuminated topper |
| 21 | 21a | AA-0175 | Modulo Hermes GPRS-GSM-GPS / Wi-Fi modello a Pinna | GPRS-GSM-GPS / Wi-Fi Module Kit - Pin Aerial model |
| | 21b | AA-0172 | Modulo Hermes GPRS-GSM-GPS / Wi-Fi modello a Disco | GPRS-GSM-GPS / Wi-Fi Module Kit - Disk Aerial model |
| | 21c | AA-0173 | Modulo Hermes GPRS-GSM modello a Pinna | GPRS-GSM Hermes Module Kit - Pin Aerial model |
| | 21d | AA-0170 | Modulo Hermes GPRS-GSM modello a Disco | GPRS-GSM Hermes Module Kit - Disk Aerial model |
| | 21e | AA-0174 | Modulo Hermes Wi-Fi modello a Pinna | Wi-Fi Hermes Module Kit - Pin Aerial model |
| | 21f | AA-0171 | Modulo Hermes Wi-Fi modello a Disco | Wi-Fi Hermes Module Kit - Disk Aerial model |
| 22 | | C-140102 | Terminale POS | POS terminal |
| 23 | | CH-CC01 | Lettore ACS di tessere e chiavi | ACS card and key RW module |

ESPLOSO EXPLODED DRAWING

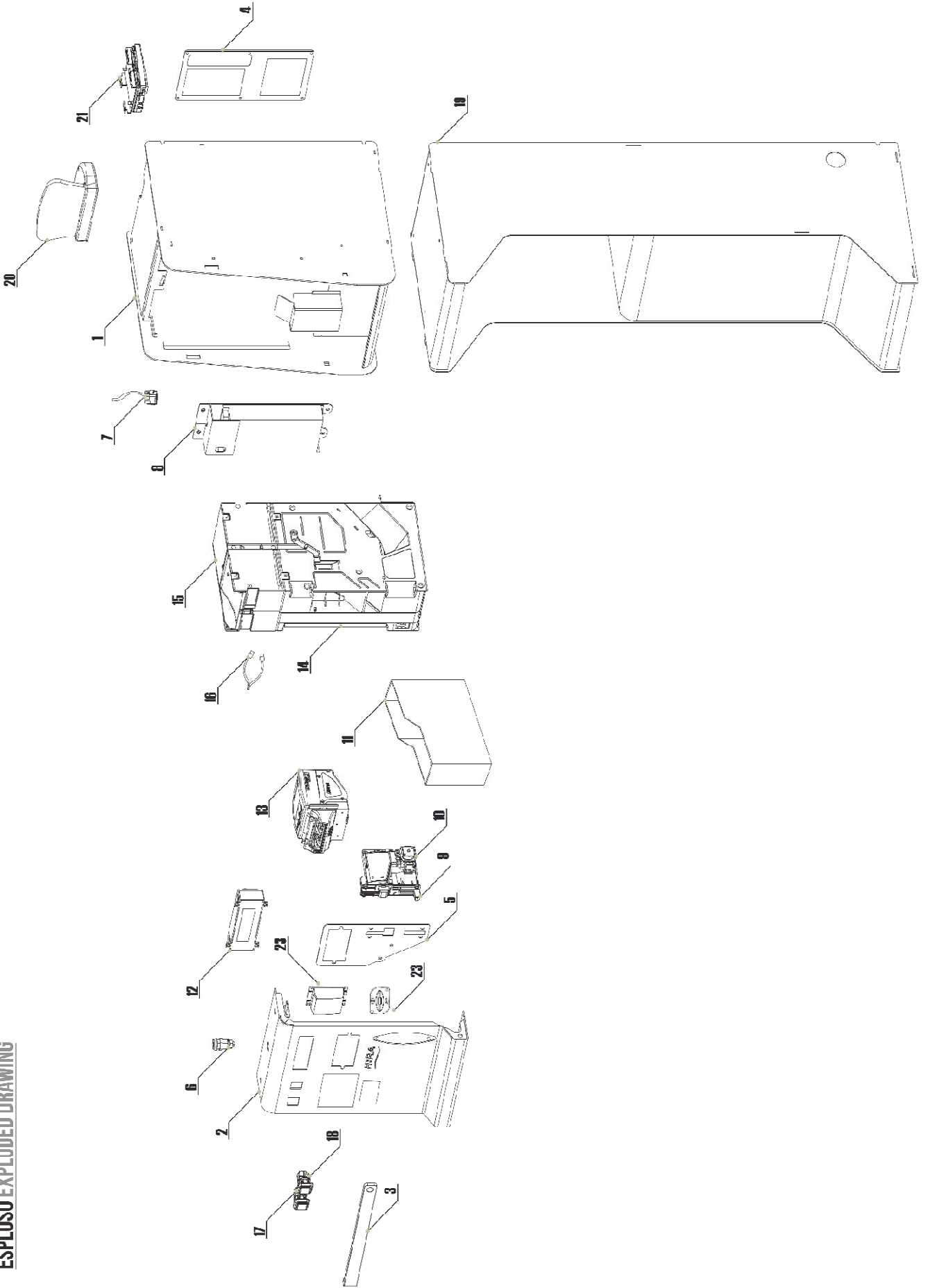



DICHIARAZIONE DI CONFORMITÀ



DIRETTIVA 2014/35/UE - DIRETTIVA 2014/30/UE

La ditta **Alberici S.p.A.**, avente sede in via **Ca' Bianca 421, 40024 Castel San Pietro Terme (BO) – Italia**,

DICHIARA

Che il sistema classificato nella famiglia di prodotto **apparecchio elettrico d'uso domestico e similare – Sistema Cambiamonete**, identificato univocamente da:

| Modello | Configurazione | N° di Serie e/o matricola | |
|-------------|--|--|-------|
| Hira | <input type="checkbox"/> One <input type="checkbox"/> D (AH4) | <input type="checkbox"/> G - One <input type="checkbox"/> G - D (AH4) | ----- |

Essendo conclusi con esito positivo i test eseguiti ai fini EMC e LVD (rapporto 4594ce2.doc del 12 ottobre 2007) dalla STP S.r.l., con sede legale in via Cervese, 373, 47521 Cesena (FC), Italia e sede operativa in via San Donnino, 4, 40127 Bologna (BO), Italia, risulta essere conforme a quanto previsto dalle seguenti direttive comunitarie:

- a) le norme armonizzate (per i punti applicabili):
- CEI EN 55014-1 (CEI 110-1);
 - CEI EN 55014-2 (CEI 210-47);
 - CEI EN 55022 (CEI 110-5);
 - CEI EN 55024 (CEI 210-49);
 - CEI EN 60065 (CEI 92-1);
 - CEI EN 60335-1 (CEI 61-150);
 - CEI EN 60335-2-82 (CEI 61-226);
 - CEI EN 60950-1 (CEI 74-2);
 - CEI EN 61000-3-2 (CEI 110-31);
 - CEI EN 61000-3-3 (CEI 110-28);
 - CEI EN 61000-4-2 (CEI 210-34);
 - CEI EN 61000-4-3 (CEI 210-39);
 - CEI EN 61000-4-4 (CEI 210-35);
 - CEI EN 61000-4-5 (CEI 110-30);
 - CEI EN 61000-4-11 (CEI 110-29);
 - CEI EN 61000-6-1 (CEI 210-64);
 - CEI EN 62233 (CEI 61-251).
- b) In conformità ai requisiti essenziali di sicurezza della Direttiva Bassa Tensione:
- L. 791 del 18 Ottobre 1977 e s.m.
 - 2014/35/UE del 26 Febbraio 2014;
- c) in conformità ai requisiti essenziali di sicurezza della Direttiva Compatibilità Elettromagnetica:
- D.Lgs. 194 del 06 Novembre 2007.
 - 2014/30/UE del 26 Febbraio 2014;

che conferiscono la presunzione di conformità alla Direttiva 2014/30/UE

Castel San Pietro Terme (BO), Italia li, ___/___/_____

Fabrizio Alberici

Il Presidente

Alberici S.P.A.

Progettazione e produzione sistemi di pagamento, accessori per videogames e vending machines

Via Ca' Bianca 421, 40024 Castel San Pietro Terme (BO), Italia

Telefono: +39-(0)51-944300 r.a. – Fax: +39-(0)51-944594 – P.Iva: 00627531205

E-mail: info@alberici.net – Url: <http://www.alberici.net>



NOTICE

Alberici S.p.A. reserves the right to change the features and the specifications to the equipment described at any time and without notice, in the pursuit of the incessant improvement of its products.



Progettazione e produzione di sistemi di pagamento, accessori per videogames e macchine vending
Design and manufacture of payment systems, accessories for videogames and vending machines

Via Ca' Bianca 421
40024 Castel San Pietro
Terme (BO) – ITALY

Tel. + 39 051 944 300
Fax. + 39 051 944 594

<http://www.alberici.net>

info@alberici.net