

BILLYONE UN1 note validator (ARM3)
BILLYONE UN1 M.S. note validator (ARM3)

Operator's Manual

Rev. 1.06



Operator's Manual



Via Cà Bianca, 421 - 40024
Castel San Pietro Terme (BO) - Italy

Progettazione e produzione di sistemi di pagamento e accessori per macchine Gaming, Vending e Car-Wash

Tel.: +39.051.944300
Fax.: +39.051.944594

Web: www.alberici.net
E.mail: info@alberici.net



NOTICE

Every possible care has been taken in the preparation of this manual.

Nevertheless, there is no guarantee at all times regarding the absolute correspondence of the descriptions contained in this manual with the characteristics of the product. The Alberici S.p.A. disclaims any responsibility towards the User with respect to damages, losses, or claims of third parties, arising from use of the product or caused by misinterpretation of this manual.

Alberici S.p.A. reserve the right to change, without notice, in any way any portion of this manual.

CONTENTS

1. General	4
2. Package contents	5
3. Product description	5
4. Mounting instructions	8
5. Messages	16
6. Maintenance	17
7. Calibration	18
8. Disposal of the Product.....	20
9. Terms of Guarantee	20
10. Customer Service	20

STORICO REVISIONI			
Revisione n°	Data	Modifica	Note
Creazione	14.06.17		
v.1.01	03.11.17	MDB su ARM 3	
v.1.02	18.12.17	Configurazione parallela in modalità PULSE / Nuova IF ccTalk	
v.1.03	14.05.18	Procedura calibrazione	
v.1.04	11.03.19	Aggiornamemto mini-USB	
v.1.05	24.07.19	Versione con sensore magnetico	
v.1.06	11.04.22	Nuove introduzioni rosse	standard 72mm EURO, 83mm UNIVERSAL, 67mm USD, 60-75mm PLN

1. General

Dear Customer,
we would like to thank you and congratulate for your choice. We trust that you will appreciate the quality and performance of our BILLYONE UN1 note validator.

1.1 Host machine design

- The manufacturer takes all possible measures to ensure the quality of this unit. However, performance decay or circuit faults could occur at the end of the product's life. Please ensure safety operation by making use of fail-safe design procedures.
- Please allow enough space around the validator to ease removal of the unit or collection of the banknotes.

1.2 Mounting

- Do not obstruct the acceptor's air intakes or else proper cooling will not be possible
- Do not use the acceptor in extreme or widely changing temperature
- Do not expose the acceptor to direct sunlight or to incandescent lighting (> 3000 Lux)
- Do not use or store the acceptor in dusty areas or in presence of chemical vapours or sprays
- The acceptor is for indoor use only. Do not use it outside.
- When using the acceptor in presence of car exhausts or smoke, please clean and maintain the acceptor often and regularly.

1.3 Wiring

- Switch power supply off before connecting or disconnecting any cables.
- When wiring the connection cable, pay utmost attention to the specified power range and pin assignment. Wrong wiring may cause unit damage.
- Connect the power cable firmly.
- Do not pull or stretch the power cable.

1.4 Caution

- When opening the Upper/Lower lid, disconnect power to the acceptor.
- When closing the Upper lid, do not put your fingers through.
- Do not modify the unit. Doing so may damage the product.
- Do not bump or drop the acceptor.
- Do not wipe or clean with thinners or organic solvents.
- Do not let moisture or liquids into or onto the acceptor.
- Do not use the acceptor outside the temperature / humidity range.
- The following banknotes might not be properly accepted, or might jam or damage the unit:
 - a. Stained, worn, moistured, torn or wrinkled banknote
 - b. Dog-eared banknotes
 - c. Banknotes with incorrect cut dimensions or printing displacement
 - d. Oil-smearred bills or with foreign bodies (i.e. sticking tape, a.s.o.)

1.5 Disposal

- Dispose of this unit according to your Country's regulations for such types of industrial waste. This product is RoHS-compliant.

2. Package contents

The package contains the following items:

1. BILLYONE UN1 note validator
2. Installation manual (this manual)

This unit has been carefully packed, with special attention to protect it against damages. However, if you find anything damaged or missing, please contact immediately your local distributor. Upon reception, please open the box and check for eventual damages, deficiencies or abnormalities, and in such case immediately report it to the forwarder and on the collection receipt.



3. Product description

The labels in the picture show the data updated to the versions of FW and HW valid at 04.06.2019.

Model: BILLYONE UN1
 Protocols: ccTalk(non-encrypted)+USBport / PulseParallel or Multi-Pulse / MDB
 VersionHW: 3.00-01 (*)
 VersionFW: u2.3 A4.0.6(*)
 MechanicalRev. RM: 5.3.0
 Power supply: +12V / +24V
 Current draw: 0,4 A (max. 1.0A)
 Currency: EURO

Default currency is EURO 5.1-10.1-20.1-50.1-100.1 (Eur I series), 5.2-10.2-20.2-50.2-100.2 (Eur II series). Please ask in advance for different needs (see Appendix 1 page 20 for the available datasets).

It is however always possible to re-program the validator for a different currency, by using the programming Interface K-P1C-000009 (or the K-P2C-000003 IF) in combination with the "AlbericiUpgLetto" software.

Inlets available are:

STANDARD VERSION:

- standard 72mm EURO red inlet (P-ALB026-002)
- 83mm UNIVERSAL red inlet (P-ALB025-002)
- 67mm USD red inlet (P-ALB025-002)
- 60-75mm PLN red inlet (P-ALB027-002)

MAGNETIC SENSOR VERSION:

- 67mm USD red inlet (P-ALB025-002)
- 83mm UNIVERSAL red inlet (P-ALB025-002)

These "MS" versions are meant to be used for CURRENCIES WITH MAGNETIC IDENTIFICATION ELEMENTS

The serial number includes the product identifier 'LB0-', followed by the progressive production no. (made up of 7 digits). Example: LB0-0084312.

The relevant data of the note validator can also be read by using the "AlbericiUpgLetto" Software:

(*) to-date: 04.06.2019

Alberici BILLY ONE U	
Pw:12V/24Vdc	ccTalk - Pulse
0.4A(max1A)	EU: 5 10 20 50 100
Cid:236	PB:EU.2.0.0.5
Rm:5.3.0	Hw:3.00-01 Fw:u2.3 A4.0.6



Alberici BILLY ONE UMS	
Pw:12V/24Vdc	ccTalk - Pulse
0.4A(max1A)	EU: 5 10 20 50 100
Cid:236	PB:EU.3.1.0.5
Rm:5.3.0	Hw:3.00-01 Fw:u2.3 A4.0.6

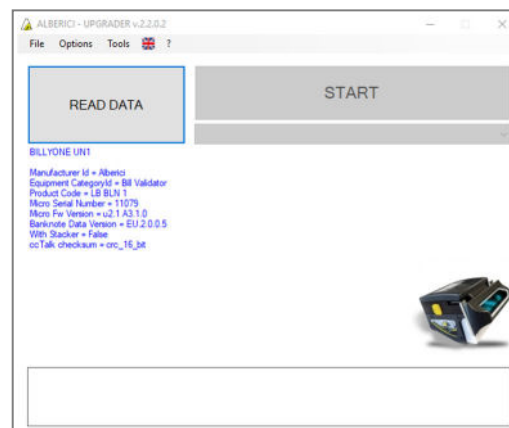

3.1 Parts description

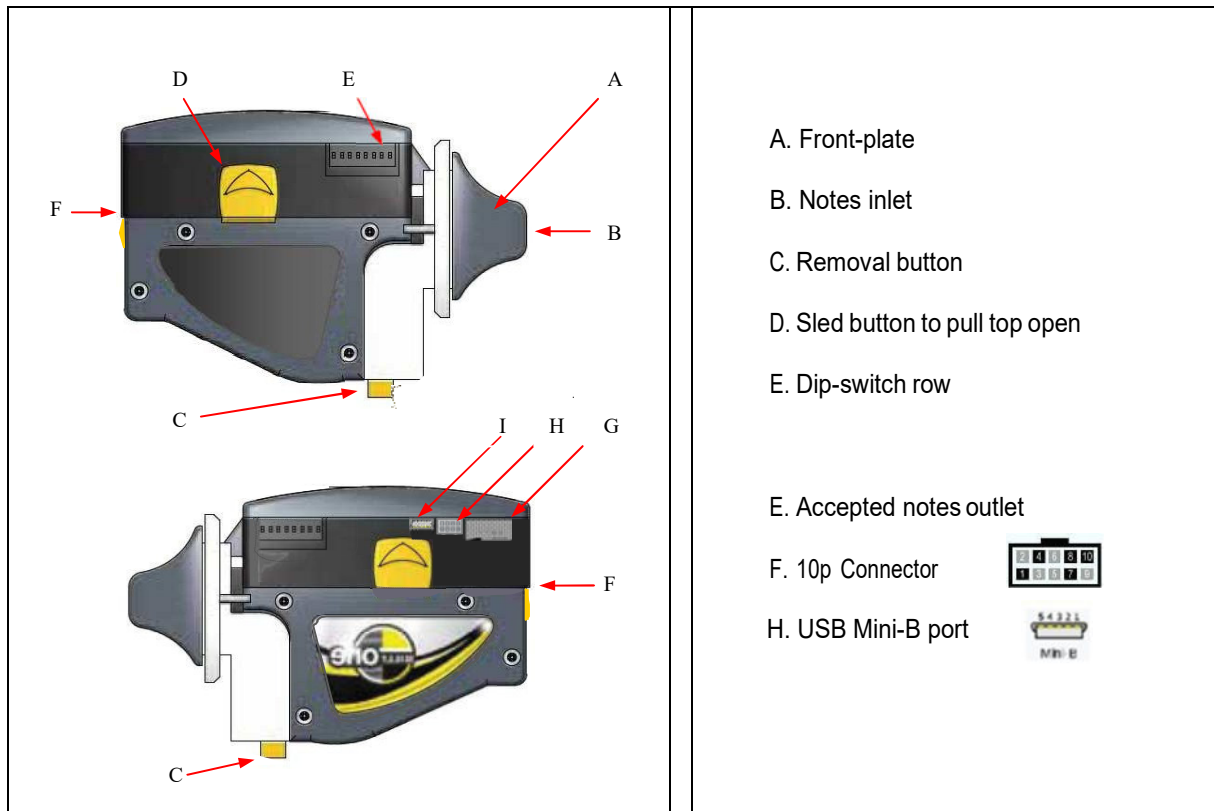

- A. Front-plate
- B. Notes inlet
- C. Removal button
- D. Sled button to pull top open
- E. Dip-switch row
- E. Accepted notes outlet
- F. 10p Connector
- H. USB Mini-B port

3.1 Technical Specifications

ALIMENTAZIONE / POWER SUPPLY	12V / 24V ±5%
ASSORBIMENTO / CURRENT DRAW	200 mA (stand-by) 400 mA (work cycle, max 1 Amp)
PROTOCOLLI / INTERFACE	ccTalk / Pulse + USB mini-B / MDB (§)
TASSO DI ACCETTAZIONE / ACCEPTANCE RATE	92% = alta sicurezza / high security setting 98% = sicurezza standard / standard security setting
TECNOLOGIE DI RICONOSCIMENTO / SCAN TECHNOLOGY	Trasparenza e riflessione (sensori IR e sensori cromatici) VHR VHR transparency and reflection (IR and colour sensors)
VELOCITÀ DI VALIDAZIONE / VALIDATION SPEED	2 sec ca. (4 versi) / approx. 2 sec (any of 4 directions)
BANCONOTE COMPATIBILI / BANKNOTE SIZE	72,0 – 83,0 mm larghezza / width - vers. \$ M.S. = 67,0 mm
TEMPERATURA DI UTILIZZO / OPERATING TEMPERATURE	0°C ÷ 50°C (senza condensa/without condensation)
TEMPERATURA DI MAGAZZINO / STORAGE TEMPERATURE	-10°C ÷ 60°C (senza condensa/without condensation)
PESO / WEIGHT	0,565 Kg

(§) The USB output is not available on the MDB version.

3.2 Dimensions

Left side view

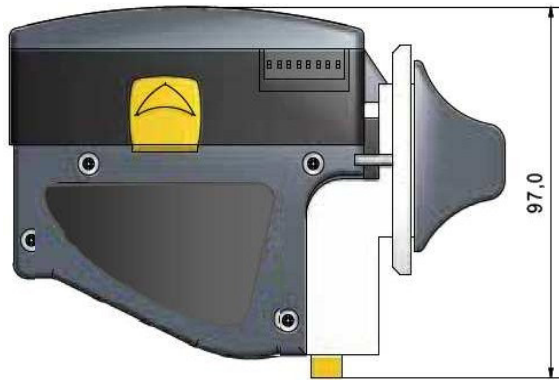

Front view

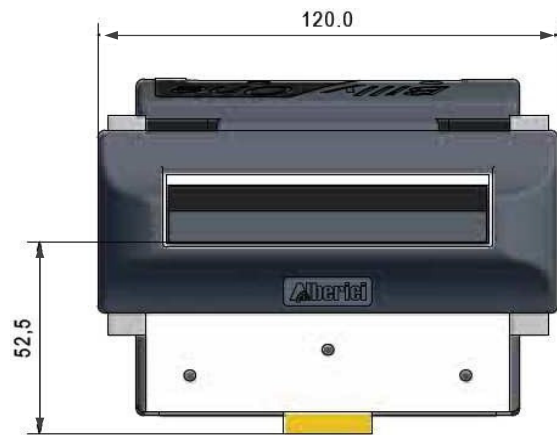

View from top



BillyOne UN1 - BillyOne UN1 Univ. M.S

Introduzioni 75mm o 83mm disponibili, a richiesta



BillyOne UN1 \$ M.S.

N.B.: All measures are in mm

4. Mounting instructions

4.1 General

Installation	Preferably indoors; always integrated into cabinets suited to the place of use.
Positioning	Positioning Level mounting on plate (protected against vibrations and shocks). Allow at least 50 cm free space on the device, in order to operate with ease when opening or removing it. Leave the back of the device free from obstacles, not to hinder accepted notes.
Notes stacker	No stacker
Light	Prevent direct sunlight from hitting the inlet: use incandescent lamps in the working environment. Gradient of incidence of the light: $> / = 15$ degrees.

The collecting box for the accepted notes should be placed behind the device and below his lower profile. Its recommended minimum size is:

min. 100 mm useful height,
min. 100 mm in width, and
min. 200 mm in length.

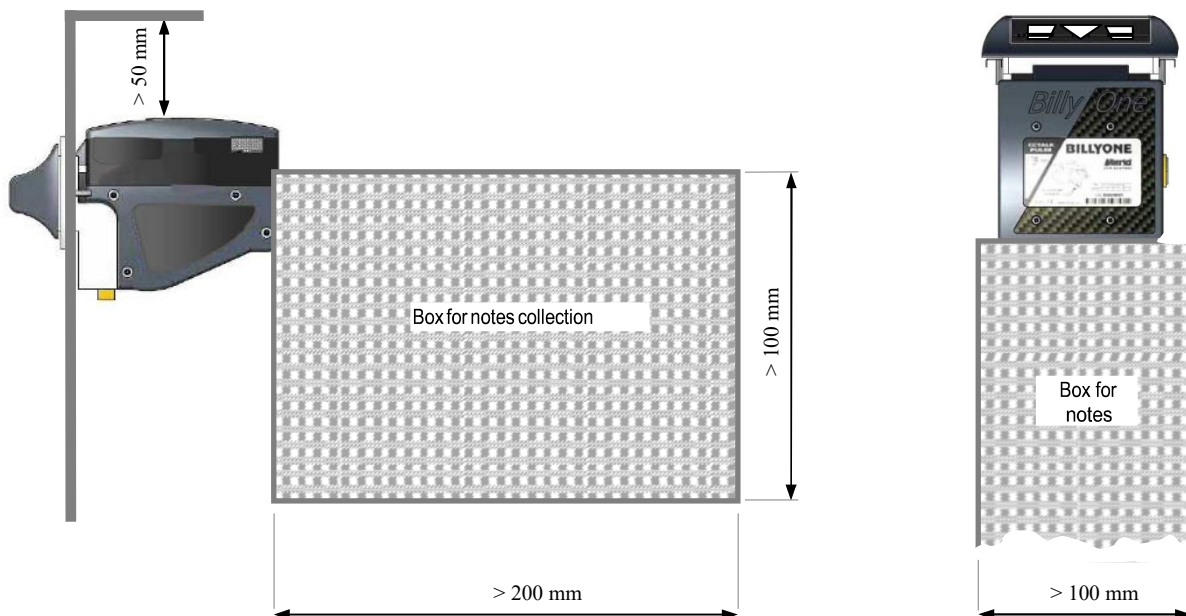

4.2 Mechanical fitting

1. Mounting panel must be up to 7 mm thick.
Cut out a window as shown in figure below, size 43mm (height) x 95mm (width).
Even a simple rectangular cut-out of 43mm (height) x 105mm (width) will do.

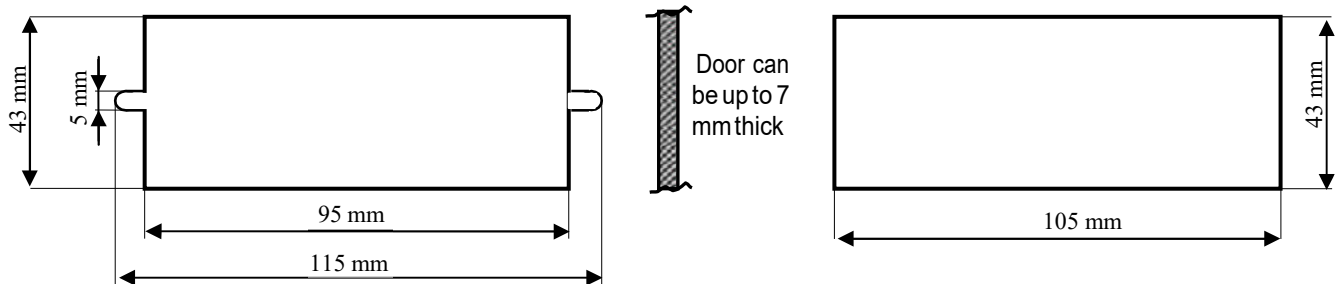

2. To release the main body from the front plate, press the yellow button C (see page 6), located under the validator, and slide the validator body backward until it comes out.

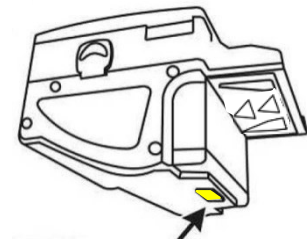

3. Remove from the front plate the two hex nuts holding the two fixing brackets.
Fit the front plate in the window provided on the panel (see point 1).

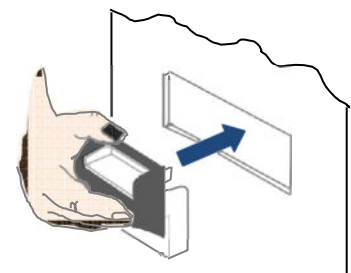

4. Fasten the front plate to the door by the 2 fixing brackets and their fixing nuts.
Take care not to tighten the nuts too much.

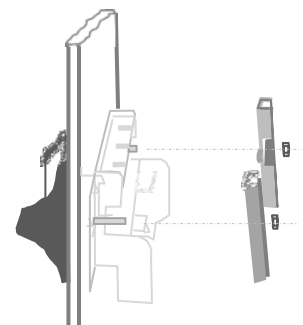

7. Insert the inlet of the note validator in the cut-out, and push the unit frontward, until it hooks in.
Make sure that the validator and its bezel are securely fixed to the door.



To remove the device, perform the above procedure from end to start.

4.3 Electrical connections and settings of the unit

The BILLYONE UN1 validator is designed for 12 Vdc or 24 Vdc power supply: it recognizes which voltage is available, and adjusts its circuit automatically. Once connected, take care that the cable is protected against any mechanical stress or accidental pull.

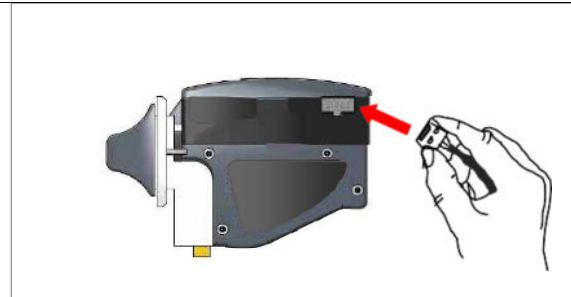

4.3.1 Connection wiring

Make use of quality components complying with the current draw values, as for example:

Socket	IDC socket	Socket for flat cable
Wire	AWG24 (UL1061)	Flat cable, pitch 1,27 mm - AWG28 (UL2651/UL20012)

To connect the validator to the machine board:

1. Make sure the power is off.
2. Insert the cable into the 10p connector.
3. Turn on the power and test for correct operation.

Starting from Rm 5.2.0, the note validator is equipped with one **mini-USB port**, that can be used for **ccTalk direct communication (without echo message)** between the validator and the host.

Win10 includes the drivers, else please download them from the validator page in our website.

ccTalk communication only flows through the mini-USB port, while power (12/24Vdc for BillyOne, or 24Vdc for OryOne) must be provided to Pin 10 (+) and Pin 8 (GND) of the 10p socket.

The note reader must be set to **ccTalk protocol (Dip-Switch 1 = ON)**. **Updating, programming, and calibration** still need the external grey USB interface (pendrive or kit) to be connected to the **10p socket**.

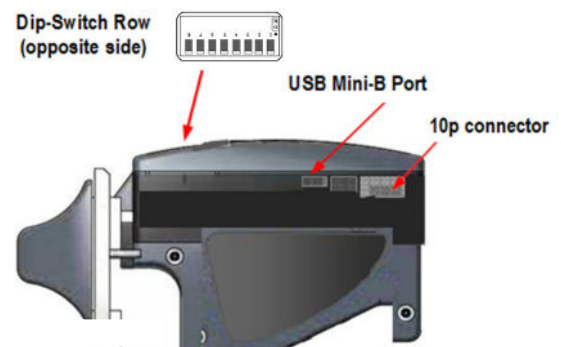

4.3.2 MDB 10p pin-out to 6p plug

When setting the reader for MDB protocol (see 4.3.4 Dip-Switch Settings), it might be necessary to adapt the 10p outputs to the 6p cable from the master Board of the machine. The drawing here aside shows the connections between the 10p socket pins and the 6p plug:



The MDB connection cable can be ordered by the # nr. S-031005-000.

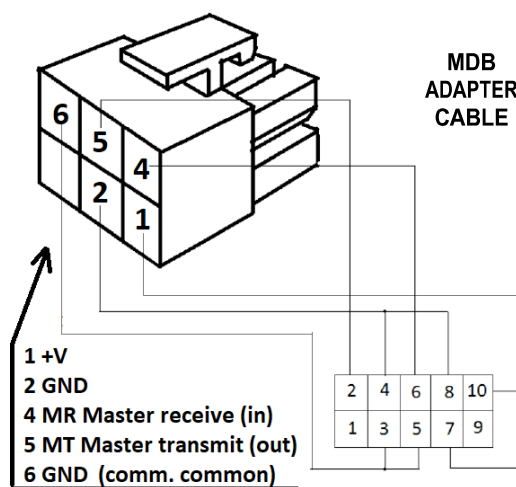

4.3.3 10 Pin interface connector



The 10p connector, for connection to the machine Master board, is located at the right side of the BILLYONE UN1 note reader.
Starting from hw 2.00 and fw u 2.1.A.3.0.6, the note validator is also equipped with one mini-USB port.

10p connector

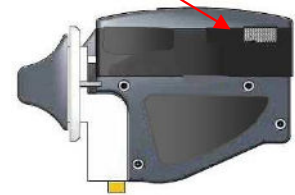

CCTALK: SW 1 = ON - SW 2 = OFF

DATA	1	2	-
-	3	4	GND
-	5	6	-
12/24Vdc	7	8	GND
-	9	10	12/24Vdc

Pin	Signal	Function	Pin	Signal	Function
1	CCT	CCT Data (active low)	6	NC	Not connected
2	NC	Not connected	7	Vcc	+12/24Vdc (Power supply)
3	NC	Not connected	8	Vss	GND (Power supply)
4	NC	GND	9	NC	Not connected
5	NC	Not connected	10	Vcc	+12/24Vdc (Power supply)

PULSE: SW 1 = OFF - SW 2 = OFF

(!) ENABLE [-] / OUT5	1	2	INH [+] (!!!)
PARALLEL OUT3	3	4	GND
PARALLEL OUT4	5	6	PARALL. OUT1
12-24Vdc	7	8	GND
TOTAL. CREDIT / OUT2	9	10	12-24Vdc

Pin	Signal Total. / Paral.	Function: Totaliz. / Parallel	Pin	Signal Total. / Paral.	Function: Totaliz. / Parallel
1	(!) ENABLE = - / PARAL. OUT5	Enable TOT. = GND / Parallel 100 €	6	VOID / PARAL. OUT1	VOID / (active Low) Parallel 5€
2	VOID / INH + (!!!)	VOID / Inhibit = +3V÷30V	7	Vdc	+ 12÷24 Vcc / + 12÷24 Vcc
3	VOID / PARAL. OUT3	VOID / (active Low) Parallel 20 €	8	GND	GND / GND
4	GND	GND / GND	9	TOTALIZER / PARAL. OUT2	(active Low) Credit Total. / Paral. 10 €
5	VOID / PARAL. OUT4	VOID / (active Low) Parallel 50 €	10	Vdc	+ 12÷24 Vcc / + 12÷24 Vcc



PULSE TOTALIZER: if pin1=GND ----> validator is enabled. If pin1= floating or +3V÷30V ----> validator disabled.

PULSE PARALLEL: if pin2= floating or GND ----> validator is enabled. If pin2= +3V÷30V ----> validator disabled.

MDB (no USB): SW 1 = OFF - SW 2 = ON

-	1	2	RX+(MDB V)
RX-(ON=NEG)	3	4	GND
TX-(OV.)	5	6	TX+(ON=NEG)
12/24Vdc	7	8	GND
-	9	10	12/24Vdc

Pin	Signal	Function	Pin	Signal	Function
1	NC	Not connected	6	TX +	Tx (Active low)
2	RX +	Rx (+V MDB)	7	Vcc	+12/24Vdc (Power supply)
3	RX -	Rx (Active low)	8	Vss	GND (Power supply)
4	GND	GND	9	NC	Not connected
5	TX -	Tx (0V MDB)	10	Vcc	+12/24Vdc (Power supply)

4.3.4 Dip-switch row and unit setting

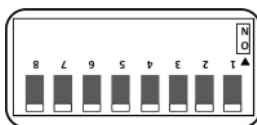

The Dip-Switches allow to set the communication mode (interface protocol) and other useful features. The DS row is located on the left side of the validator.

BEWARE! The functions that can be set by Dip-Switch in the BillyOne UN1 do not correspond to the ones in the previous BillyOne generation.

Examples of communication settings of the interface by DS5, DS6, DS7

Ex. 1: for operation in ccTalk mode, move the dip-switch 1 to ON:



Ex. 2: for operation in Pulse mode, 1 € = 1 pulse, 200mA pulse length:



SW N°	DIP-SWITCH FUNCTIONS		
SW 1 e	SW 1	SW 2	Protocol Interface Mode
	OFF	OFF	Pulse
	ON	OFF	ccTalk
	SW 2	SW 2	
	OFF	ON	MDB
	ON	ON	SAS
SW 3	SW 3		Pulse communication modes
	OFF		Pulse Parallel Outputs (Out 1 = 5€, Out2 = 10€, Out3 = 20€, Out4 = 50€, Out5 = 100€)
	ON		Pulse Accumulator Output (see SW 4 / SW 5)
SW 4 e	SW 4	SW 5	Accumulator value (only for Pulse mode)
	OFF	OFF	5 Euro = 1 Pulse
	OFF	ON	5 Euro = 5 Pulses (1 Euro = 1 Pulse)
	SW 5	SW 5	
	ON	OFF	10 Euro = 5 Pulses (5 € disabled)
	ON	ON	5 Euro = 10 Pulses (1 Euro = 2 Pulses)
SW 6	SW 6		Acceptance rate / Anti-fake Security level
	OFF		!!!! Acceptance 98% = Standard security level !!!!
	ON		Acceptance 92% = High security level (false notes mode)
SW 7	SW 7		Pulse length (only for Pulse mode)
	OFF		100 msec. / 100 msec. (time ON / time OFF)
	ON		200 msec. / 200 msec. (time ON / time OFF) - re-programmable
SW 8	SW 8		Activation of Anti-Fraud signals
	OFF		Anti-fraud override enabled: first 3 attempts are signaled, + 2 attempts cause 15' inactivity, with yellow flashes (see ** in Table AF: ANTI-FRAUD OPERATION MODES)
	ON		Anti-fraud override disabled: the note gets rejected with no fraud attempt signals (see *** in Table AF: ANTI-FRAUD OPERATION MODES)

Please pay attention: after any change in the DS settings, power must be turned off and then on again, so that the validator can detect the set operation mode.

(*) The pulse length can be modified by the dedicated function available in the Alberici Upg programming software menu. Such programming software is available for download in our Website.

Table AF: ANTI-FRAUD OPERATION MODES

() Dip-Switch SW8 = OFF**

Progressive attempt no.	Reaction of the Validator	Measure to be taken	Progressive attempt no.	Reaction of the Validator	Measure to be taken
1st	Remains in operation	-	4°	> error (sequence of 3 red flashes)	Switch off and then on
2nd	Remains in operation	-			
3rd	> error (sequence of 3 red flashes)	Switch off and then on			
After the 5th fraud attempt (3 yellow flashes), it is necessary to wait for automatic restore of service. Take care not to switch the device off.					

(*) Dip-Switch SW8 = ON**

Any attempt at "fishing" will cause the note to be rejected, without showing any visible signal.

Solid yellow light

Error in ccTalk communication.
Check voltage level (12 or 24Vdc). Power the device off and on.

4.3.5 Enable/Disable programmed denominations

All the notes of the programmed currency are factory enabled. The denominations are stocked in the validator memory. It is possible to disable/re-enable one (or more) denomination(s) by following the steps described below:

- *Disabling banknotes*

Move DS No. 1, DS No. 4 and DS 5 to ON position.
Turn power on: the front plate LED will light up white.
Insert the banknote that you want to disable. The LED will blink yellow 3 times when the note is returned, to mean that the note has been disabled. Insert the following banknote that you want to inhibit, or switch power off and on again.



- *Enabling banknotes*

Move DS No. 1 and DS No. 4 to ON position.
Turn power on: the front plate LED will light up white.
Insert the banknote that you want to enable. The LED will blink green 3 times when the note is returned, to mean that the note has been enabled. Insert the following banknote that you want to enable, or switch power off and on again.

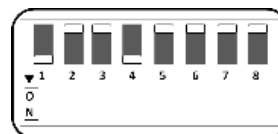

When finished, put all the DS in their original position (eg. for operating in ccTalk, all DS must be in OFF position).

NOTICE: enabled and disabled banknotes are signalled at device switch-on, depending on the number of coloured flashes from the faceplate LED.

The LED in the front panel flashes as many times as the total number of the programmed denominations; e.g., for the EURO, it flashes 5 times (1st flash = €5 banknote, 2nd flash = €10 note, 3rd flash = €20 banknote, 4th flash = €50 banknote, 5th flash = 100€ banknote). If the LED flashes green, the bill is enabled; if it flashes yellow, the note is disabled.

For example, if the denominations of 5, 10, 50 Euro are set to be accepted, and the denominations from 20 and 100 Euros are set to be inhibited, the 1st, 2nd, and 4th flashings will be in green colour, while the 3rd and 5th flashing will be in yellow.

4.3.6 ccTalk Interface circuit

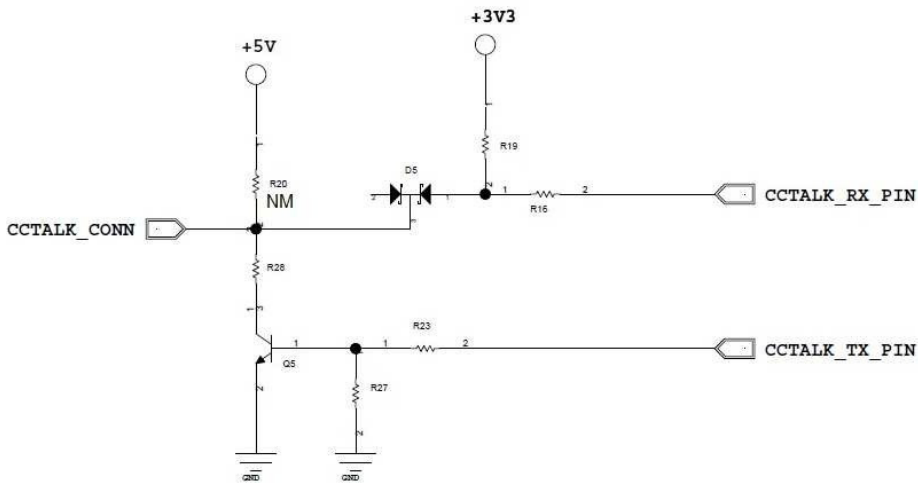

The Note Validator operates by default by 16bit CRC Checksum.
 To convert 16bit to simple checksum (8bit), please make use of the Alberici Update Software (available on <https://www.alberici.it/eng/products/note-validators/without-stacker/billyone, in the Download section>).

- Open the Options menu and set checksum as follows:
- 1) **OPTIONS:** choose and open **ADVANCED OPTIONS:** choose "Menu Tool: Enable all tools"
 - 2) **TOOLS:** "Set device parameters"; choose either "simple checksum" (8-bit) or "16-bit CRC", then press OK.

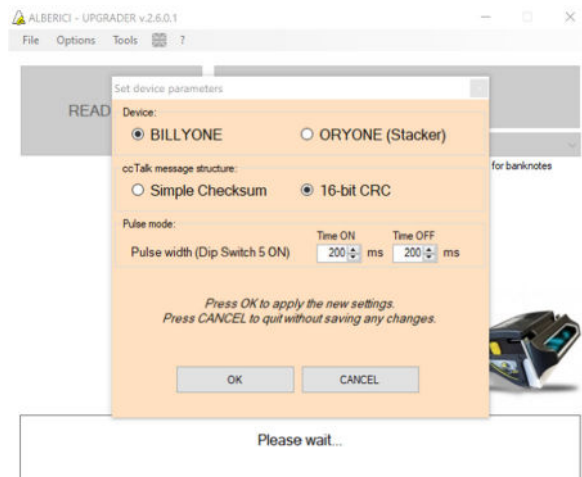

4.3.7 MDB 10p output

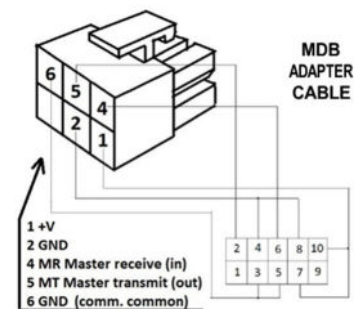
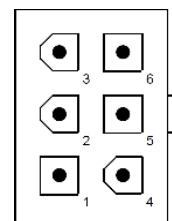
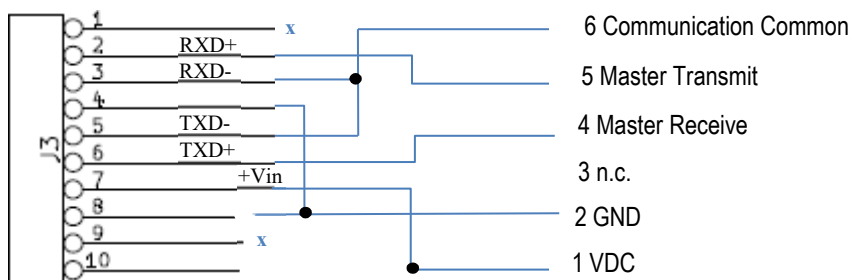

The MDB version supports all the standard (Level 1) MDB commands.

When setting the reader for MDB protocol (see 4.3.4 Dip-Switch Settings), the 10p output must be converted to the 6p MDB standard cable from the master pcb of the machine. Adapter cable is available (ref. S-031005-000).

4.3.8 Supported ccTalk headers (16-bit Cyclic Redundancy Check)

Supported Specifications

CcTalk supported specifications list

1. cctalk Generic Specification Issue 3.2
2. cctalk Expansion for Bill Validators Issue 2.1

Supported Command Headers

CcTalk supported commands list

1. Core Commands

Header 192 - Request build code
Header 244 - Request product code
Header 245 - Request equipment category id
Header 246 - Request manufacturer id
Header 254 - Simple poll

2. Core Plus Commands

Header 001 - Reset device
Header 004 - Request comms revision
Header 241 - Request software revision
Header 242 - Request serial number

3. Bill Validator Commands

Header 145 - Request currency revision
Header 152 - Request bill operating mode
Header 153 - Modify bill operating mode
Header 154 - Route bill
Header 156 - Request country scaling factor
Header 157 - Request bill id
Header 159 - Read buffered bill events
Header 197 - Calculate ROM checksum
Header 213 - Request Option flags
Header 216 - Request data storage availability
Header 227 - Request inhibit status
Header 228 - Modify master inhibit status
Header 230 - Request inhibit status
Header 231 - Modify inhibit status
Header 247 - Request variable set

5. Fault and functional messages

5.1 Error warnings: red flashes - yellow flashes - blue flashes

The number of flashes emitted from the front plate allows to check the possible reason for malfunction.

N° of red flashes	Description
1	Validator is open
2	Jammed banknote
3	Fraud attempted
5	Adjust optics
7	-
9	Low power supply
11	Check encoder+motor efficiency
12	-
14	ROM error

If ccTalk communication drops off, the validator face led will lit up solid yellow:

Solid yellow light	Error in ccTalk communication. Check voltage level (12 or 24Vdc). Power the device off and on.
---------------------------	---

Regular blue blinkings	Position of dip-switch 1 is not compatible with host communication mode.
-------------------------------	--

The banknote reader is equipped with a security device that gets activated in the event of fishing fraud attempts repeated over a period of time. This device can be set through the dip-switch SW8 to operate in a "soft" mode (* DS8 = ON) or in "extended" mode (** DS8 = OFF).

(*) Dip-Switch SW8 ON
Any attempt at "fishing" will cause the note to be rejected, without showing any visible signal.

(**) Dip-Switch SW8 OFF		
Attempt	Validator reaction	Do as described below
1°	Remains in service	-
2°	Remains in service	-
3°	> error (3 red flashes)	Reset (switch off then on)
... n° ...	> error (3 red flashes)	Reset (switch off then on)
<i>After the 5th fraud attempt (3 yellow flashes), it is necessary to wait for automatic restore of service. Take care not to switch the device off while waiting.</i>		

NOTICE: no error status is communicated to the machine, so that the latter does not go out of service, and then continue to maintain the other functions working.

6. Maintenance

6.1 Manual cleaning

The ability of acceptance may decrease due to the accumulation of dust and cellulose dust released by banknotes during transit, or because of residues or sprays, which may spread on the detecting sensors and on transmission parts. It is therefore recommended that you **clean these parts monthly**, as indicated below.

1. Turn off the power and unplug the cable from the 10-pin connector interface. Press the yellow button C, located under the reader, to release the main body from the faceplate, and slide it backwards.

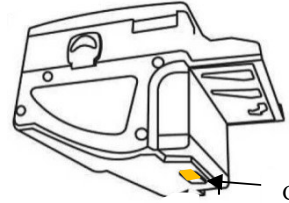

2. Move the D button upward, hold it while sliding the cover backwards; then lift the latter up and rotate it 180° to the right side.

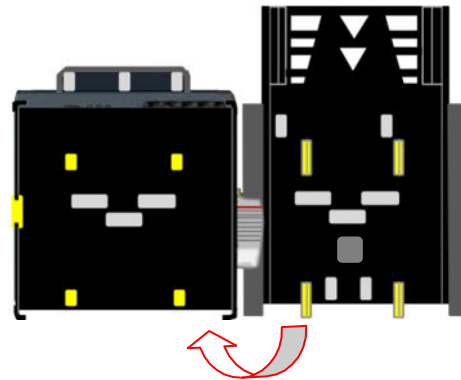
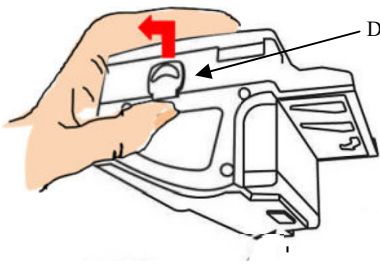

3. Gently wipe the sensors with a clean, lint-free tissue, or with a cotton swab, or with a small sponge, possibly moistened with isopropyl alcohol.
4. Completely remove the dust and residues from the 4 silicone rollers, and from the 4 elastic matching wheels which are located in the lower surface of the upper lid. To remove the most stubborn dirt from rollers and wheels, use *isopropyl alcohol*.

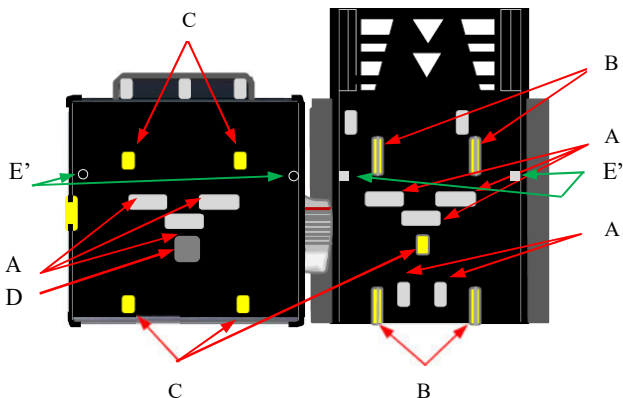

PAY ATTENTION: *do not use organic detergents (ex. alcohol, thinners, or petrol). Use only isopropyl alcohol.*

- A. Optic Sensors
- B. Traction Rollers
- C. Elastic matching wheels
- D. Magnetic sensor (only in LB-MU02, LB-LU11, LB-MU12)
- E'-E''. Alignment sensors (spray pressurized air into the holes)

6.2 Jammings

CAUTION! Turn off power before opening its upper lid.
Open the top cover by pressing D, as described in section 6.2.1 (point 2), and pull out the stuck banknote (as well as any other objects that will hinder the transit).

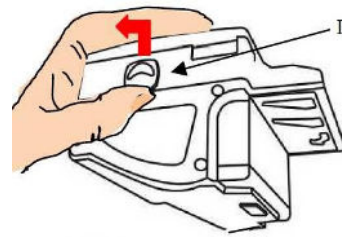

7. Calibration

Calibration should be carried out when acceptance rate decreases substantially, and/or after thorough cleaning of the note validator and particularly of its optic sensors glasses.

Full Calibration requires usage of the Alberici Calibration Card (AA-0245). A more basic calibration (Partial Calibration) can be carried out as well without such Card.

Calibration operation is part of the Firmware Update tool 'AlbericiUpgLettore.exe' (see directions for use "Instructions - ENG - BillyOne, OryOne update", available on the web site).

Launch the 'AlbericiUpgLettore.exe' Software, and open its Tools Menu and select 'Calibration', then choose 'Full Calibration' or 'Partial Calibration'.

Full Calibration :

you will be prompted to use the Calibration card. Place the Card and press OK.

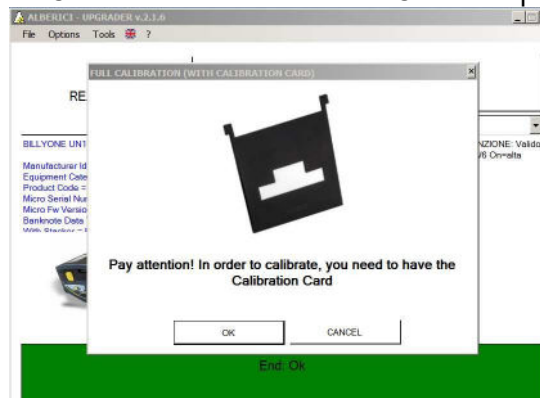

If the 'Enable advanced functionalities' box in 'Options/Advanced' has been ticked, the program will ask to choose between High Sensibility (factory default) and Low Sensibility. Tick the desired choice, then OK.

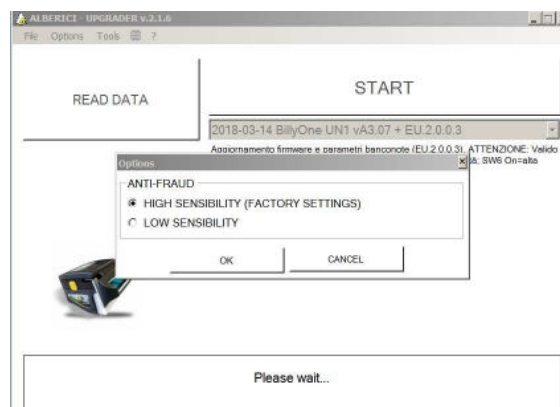

Once made your choice, or straight away if the 'Enable advanced functionalities' box has not been preset, calibration will start. If the card is not in, the system will remind you to insert it and restart the process:



Once positioned the Calibration Card, press OK button and wait until confirmation of process ended.

Partial Calibration:

If the 'Enable advanced functionalities' box has been ticked in the 'Options/Advanced', the program will ask to choose between High Sensibility (factory default) and Low Sensibility. Tick the desired choice, then OK.

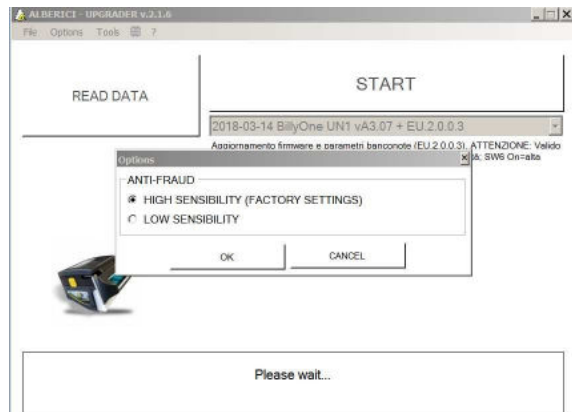

Once made your choice, or straight away if the 'Enable advanced functionalities' box has not been preset, you will be reminded to check that the validator is empty and closed.

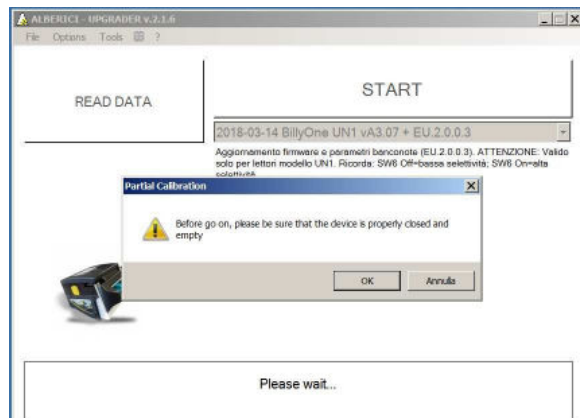

Press OK: shortly after, the program will confirm the end of the Partial Calibration:

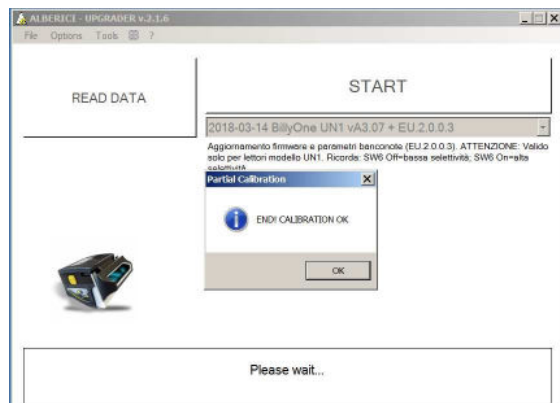

8. Disposal of the Product

WARNING! DISPOSE OF THIS DEVICE ACCORDING TO THE GOVERNING LAW IN YOUR COUNTRY!

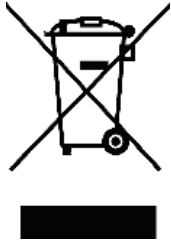

This equipment may not be treated as household waste. Instead, it must be handed over to the applicable collection point for the recycling of electric and electronic equipment. By ensuring that this product is disposed of correctly, you will help to prevent potential negative consequences for the environment and human health, which could otherwise be caused by inappropriate waste handling of this product. For more detailed information about recycling of this product, please contact the Dealer where you purchased this product.

Ref.: D. Lgs. 151/2005 – Directive 2002/96/EC

9. Terms of Guarantee

The manufacturer will fix malfunctions arising from production faults in this device or its parts within 12 months from the date of sale.

All communications referring to guarantee repairs or replacements must be accompanied by the product serial number and the copy of the sale invoice.

To obtain your guarantee repair, please send the item to the Dealer where you purchased the machine, together with the following documents:

- copy of the sale invoice
- delivery note stating "returned for guarantee repair"
- detailed report of the problem found and the circumstances in which it occurs.

Before sending the product, please get in touch with your Dealer or with Alberici S.p.a. (+39 051 944300); very often, malfunctions can be fixed via a simple phone call, saving you costs and time.

Alberici S.p.a. will verify that warranty is applicable, i.e. that problem is not caused by:

- transport damages
- damages from incorrect installation or wrong configuration
- installation in premises or areas not complying with the prescribed safety requirements
- intentional or unwilling tampering
- wrong or careless use or maintenance
- non-compliance with precautions prescribed (see Chapter 4. Caution)
- natural disasters, vandalisms, intentional or unintentional damage

Guarantee will be considered automatically expired if outer and inner labels are missing.

Transport costs of repaired products are at the Customer's charge.

10. Customer Service

Alberici S.p.a. will be pleased to offer all the necessary information on use, ordinary maintenance and technical service. Please call (+39) 051 944300 and specify if your request concerns information on use or technical support.

Appendix 1: List of available currencies ⁽¹⁾

AE	AE Dirham UA Emirates	GB	GBP Pound Sterling UK	RO	ROM Lei Romania
BA	KM Marka Bosnia	GE	GEL Lari Georgia	RS	DIN Dinar Serbia
BGN	Leva Bulgaria	HR	HRK Kuna Croatia	RU	RUB Ruble Russia
BR	BRR Rial Brazil	HU	HUF Florint Hungary	SE	SKK Krona Sverige
CH	FRS Franc Switzerland	IL	SKL Shekel Israel	UA	GRV Hryvnia Ukraine
CH-EU	FRS Franc Switzerland + Euro	KZ	KZT Tenge Kazakhstan	UZ	UZB Som Uzbekistan
CZ	CZK Krana Czech Republic	LBP	Pound Lebanon	US	US Dollar USA (<i>only versions with Magnetic Sensor</i>)
DK	DKK Krona Denmark	MD	MDL Leu Moldavia	ZAR	Rand South Africa
EU	Euro Europe	MXN	Peso Mexico		
		PL	PLN Zloty Polska		

Please contact us for any other currencies that you may need

(1) As of 31.12.2022



DICHIARAZIONE DI CONFORMITÀ



DIRETTIVA 2014/35/UE - DIRETTIVA 2014/30/UE

La ditta **Alberici S.p.A.**, avente sede in via **Ca' Bianca 421, 40024 Castel San Pietro Terme (BO) – Italia**,

DICHIARA

che il sistema classificato nella famiglia di prodotto **apparecchio elettrico d'uso domestico e similare – Lettore di Banconote BillyOne**, identificato univocamente da:

Modello	Configurazione	Version	Tipo	N° di Serie e/o matricola
BILLYONE	<input type="checkbox"/> ccTalk - Pulse <input type="checkbox"/> MDB – Pulse	<input type="checkbox"/> Magnetic Sensor	<input type="checkbox"/> 12 Vdc <input type="checkbox"/> 24 Vdc	-----

essendo realizzato conformemente al modello campione denominato LB-LC01 avente matricola n° LB-LC01 (00)00000009/2013, finito di testare positivamente ai fini EMC e LVD (rapporto 6634CE-BILLYONE.doc) il 18/11/2013, dalla STP S.r.l., con sede legale in via P.F. Andrelini, 42, 47121 Forlì (FC), Italia e sede operativa in via San Donnino, 4, 40127 Bologna (BO), Italia, risulta essere conforme a quanto previsto dalle seguenti direttive comunitarie:

- a) le norme armonizzate (per i punti applicabili):
- CEI EN 55014-1 (CEI 110-1);
 - CEI EN 55014-2 (CEI 210-47);
 - CEI EN 55022 (CEI 110-5);
 - CEI EN 55024 (CEI 210-49);
 - CEI EN 60065 (CEI 92-1);
 - CEI EN 60335-1 (CEI 61-150);
 - CEI EN 60335-2-82 (CEI 61-226);
 - CEI EN 60950-1 (CEI 74-2);
 - CEI EN 61000-3-2 (CEI 110-31);
 - CEI EN 61000-3-3 (CEI 110-28);
 - CEI EN 61000-4-2 (CEI 210-34);
 - CEI EN 61000-4-3 (CEI 210-39);
 - CEI EN 61000-4-4 (CEI 210-35);
 - CEI EN 61000-4-5 (CEI 110-30);
 - CEI EN 61000-4-11 (CEI 110-29);
 - CEI EN 61000-6-1 (CEI 210-64);
 - CEI EN 62233 (CEI 61-251).
- b) In conformità ai requisiti essenziali di sicurezza della Direttiva Bassa Tensione:
- 2014/35/UE del 26 Febbraio 2014;
 - L. 791 del 18 Ottobre 1977 e s.m.
- c) in conformità ai requisiti essenziali di sicurezza della Direttiva Compatibilità Elettromagnetica:
- 2014/30/UE del 26 Febbraio 2014;
 - D.Lgs. 194 del 06 Novembre 2007

che conferiscono la presunzione di conformità alla Direttiva 2004/108/CE

Castel San Pietro Terme (BO), Italia, li, ___ / ___ / ___

Felizio Alberici

Il Presidente

Alberici S.P.A.

Progettazione e produzione sistemi di pagamento, accessori per videogames e vending machines

Via Ca' Bianca 421, Zona industriale, 40024 Castel San Pietro Terme (BO), Italia

Telefono: +39-(0)51-944300 r.a. – Fax: +39-(0)51-944594 – P.Iva: 00627531205

E-mail: info@alberici.net – Url: <http://www.alberici.net>



NOTICE

Alberici reserves the right to change at any time any part in the present manual, as well as in the product and in its functions, without previous notice, to the aim of continuously improve the quality of the products.



Progettazione e produzione di sistemi di pagamento, accessori per videogames e macchine vending
Design and manufacture of payment systems, accessories for videogames and vending machines

Via Ca' Bianca 421
40024 Castel San Pietro
Terme (BO) – ITALY

Tel. + 39 051 944 300
Fax. + 39 051 944 594

<http://www.alberici.net>

info@alberici.net