

Timebox B 2-line pay-for-time system

Operator's manual

Rev. 1.03



Operator's Manual

CE

Alberici[®]
CASH SOLUTIONS

Progettazione e produzione di sistemi di pagamento e accessori per macchine Gaming, Vending e Car-Wash

Via Cà Bianca, 421 - 40024
Castel San Pietro Terme (BO) - Italy

Tel.: +39.051.944300
Fax.: +39.051.944594

Web: www.alberici.net
E.mail: info@alberici.net

NOTICE

This manual has been prepared with the utmost care. Nevertheless, it is not possible to assure at any time the exact correspondence of the descriptions to the product features. Alberici SpA shall not be held liable by the User for any damage, losses, or third party claims arising from any uses of the manual or of the product.

CONTENTS

1. Package content.....	5
2. Product description	5
3. Size.....	6
4. Electrical connections	6
5. Operation.....	8
6. Product disposal	11
7. Terms of Guarantee.....	11
8. Customer Service	11

STORICO REVISIONI

Revisione n°	Data	Modifica	Note
Creazione 1.00	21.10.08	Creazione	
Rev. 1.01	12.03.10	Aggiunto comando a contatto pulito	
Rev. 1.02	04.04.14	ActiveOne, scheda MKII e conversione a ccTalk	
Rev. 1.03	22.07.15	Cambio frontespizio	

Dear Customer,

we would like to thank you and congratulate for your choice. We trust that you will appreciate the quality and performance of the Alberici TIMEBOX S.

This unit operates by cctalk protocol, the serial communication mode that provides security and precision.

Please read carefully this handbook, to obtain the most from your TIMEBOX S Unit

1. Package content

The set includes:

1. Timebox unit
2. This manual

This product has been packed with the utmost care. If you receive it damaged or incomplete, please notify immediately your findings to the Carrier, and collect it only under conditional signature.

2. Product description

2.1 Intended use

The TIMEBOX allows to purchase any of the two available pay-for-time service. Time is purchased by introducing coin(s), then choosing the desired service by pressing the relevant onboard button keys. Price and time for service can be set at any time, by entering the programming section of the menu.

The unit can be installed outdoor, *provided it is located in a position conveniently sheltered from unfavourable weather conditions.*

2.2 Available functions

- Payment and independent activation of 2 service lines
- Accounts audits on display (access to Audits by internal pushbuttons)
- Ad libitum Custom configuration of price and time (access modifications by internal pushbuttons)

2.3 General Data

Size:	125 mm x 116mm x 390 mm
Weigh:	5,50 Kgs.
Power supply:	230V o 24Vca o +24Vcc o 12Vcc (must be specified when placing the order)
Highest current at relay contacts:	8 Amps
Working temperature:	+10°C ÷ +50°C (humidity 10% ÷ 70% non-condensed)
Installation:	Wall-mount, indoor or outdoor (sheltered against water, sprays, direct sunlight)
Components:	
Coin acceptor	AL66V cctalk
Control board	Active One
Interface service board	Alberici Servo MKII

2.4 Caution



- 1 - Comply with the instructions in this manual
- 2 - Switch power off before any maintenance operation
- 3 - Use only within the recommended temperature/humidity range
- 4 - Do not expose the machine to direct sun light,
- 5 - Do not favour contact with dusts or chemical moisture or sprays, water or other liquids
- 8 - Wipe clean by a dry piece of cloth (or slightly wet with alcohol)
- 9 - Do not use thinners or organic solvents

3. Size



4. Electrical connections



Electrical cables must not be powered during installation!

The TIMEBOX B is available for 4 different power supplies: 230Vac, 24Vac, 24Vdc, 12Vdc. When placing your orders, please specify which presetting you need: the interface Servo-board shall be prepared accordingly.

4.1 Active One control board

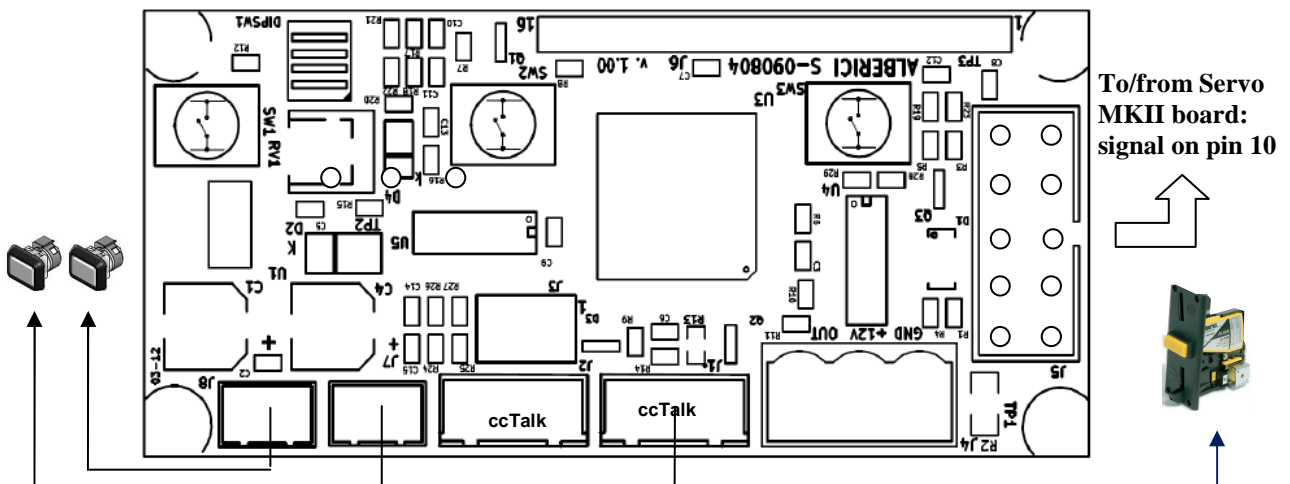

SW1 = UP key:
 menu scroll, value increase
 SW2 = DOWN key:
 menu scroll, value decrease
 SW3 = OK key:
 confirm

J1 (1x4 pins): ccTalk socket to electronic validator
 J2 (1x4 pins): ccTalk socket to (optional) RFID key reader
 J3 (2x3 pins): manufacturer use only
 J4 (1x3 pins): power supply, and credit output signal (2= 12Vcc, 3= GND, 1= credit signal)
 J5 (2x5 pins): socket to the Servo board. Totalizer output at pin 9 (out 3 = credit signal)
 J6 (1x16 pins): display
 J7 (2x3 pins): pushbutton (A) for service line 1
 J8 (2x3 pins): pushbutton (B) for service line 2

4.2 Servo-control board

A 10p flat cable connects the Active One control board to the Servo-board.

Power the Servo-board by the 3p socket J1, according to the following pattern:

	230 Vac	24Vac	24Vdc	12Vdc
Pin 3:	line 230Vac	line24Vac	+24Vdc	+12Vdc
Pin 2:	neutral	neutral	0Vdc	0Vdc
Pin 1:			GND	GND

4.2.1 Connections to start the equipment by relay transmission of power supply:

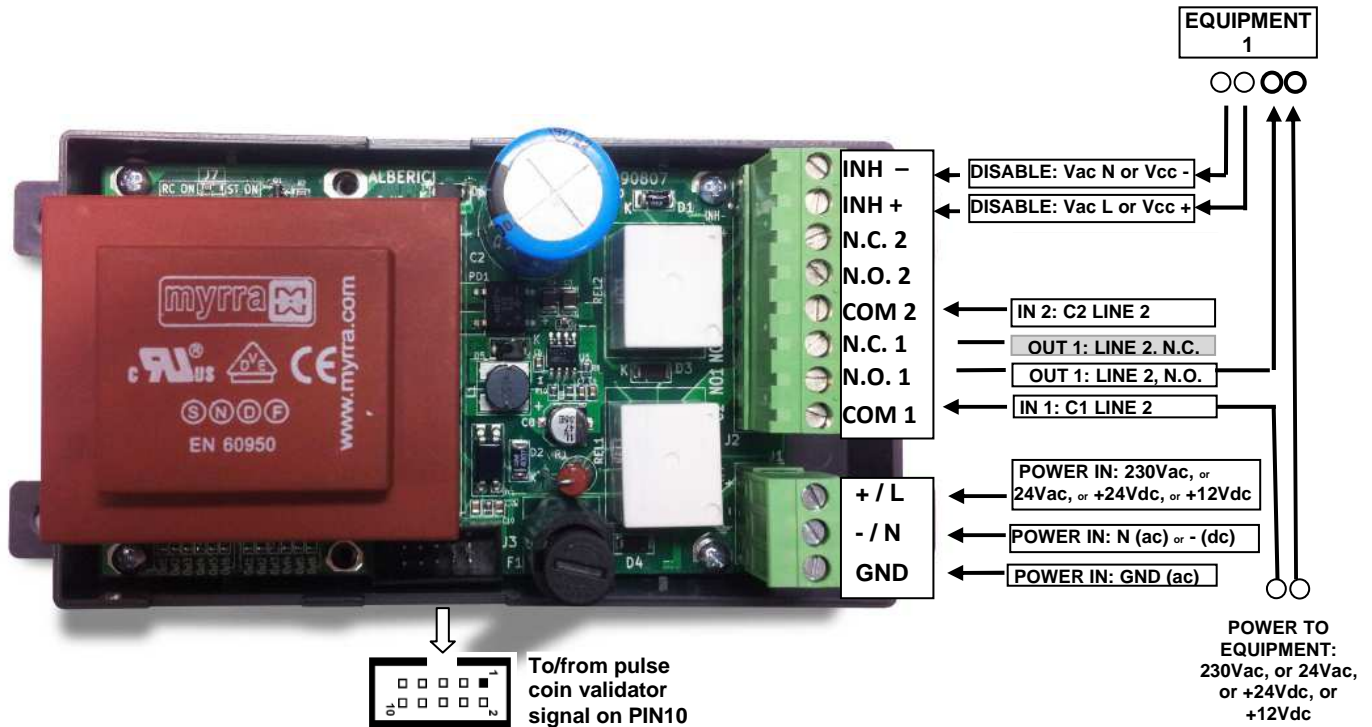

Service line 1 (Pushbutton A): from power supply, connect one end of service line 1 straight to the relevant actuator (i.e. electrical motor, solenoid, a.s.o.). Connect the other end to pin 1 (COM 1) of J2 connector.

If operation mode is “normally open”, take the switching wire to the 1 actuator from pin 2 (N.O. 1). These wires must be able to sustain 10 Amps current draw.

If operation mode must be “normally closed”, take the switching wire to the actuator from pin 3 (N.C. 1).

If the actuator works by d.c., take care to connect properly positive and negative poles!

Service line 2 (Pushbutton B): from power supply, connect one end of service line 2 straight to the relevant actuator (i.e. electrical motor, solenoid, a.s.o.). Connect the other end to pin 4 (COM 2) of J2 connector.

If operation mode is “normally open”, take the switching wire to the 2 actuator from pin 5 (N.O. 2). These wires must be able to sustain 10 Amps current draw.

If operation mode must be “normally closed”, take the switching wire to the actuator from pin 6 (N.C. 2).

It is possible to disable coin acceptance in any of the following two ways:

- Electronically - Pins 7/8 of green connector J2: provide any Vdc (+) or Vac (line value) to pin 7, and respectively 0Vdc (-) or Neutral Vac to pin 8.
- Mechanically - move to OFF the dip-switches located on the coin acceptor. Move them back to ON when you want to resume coin acceptance.

Connections to start the equipment by one clean relay switch:

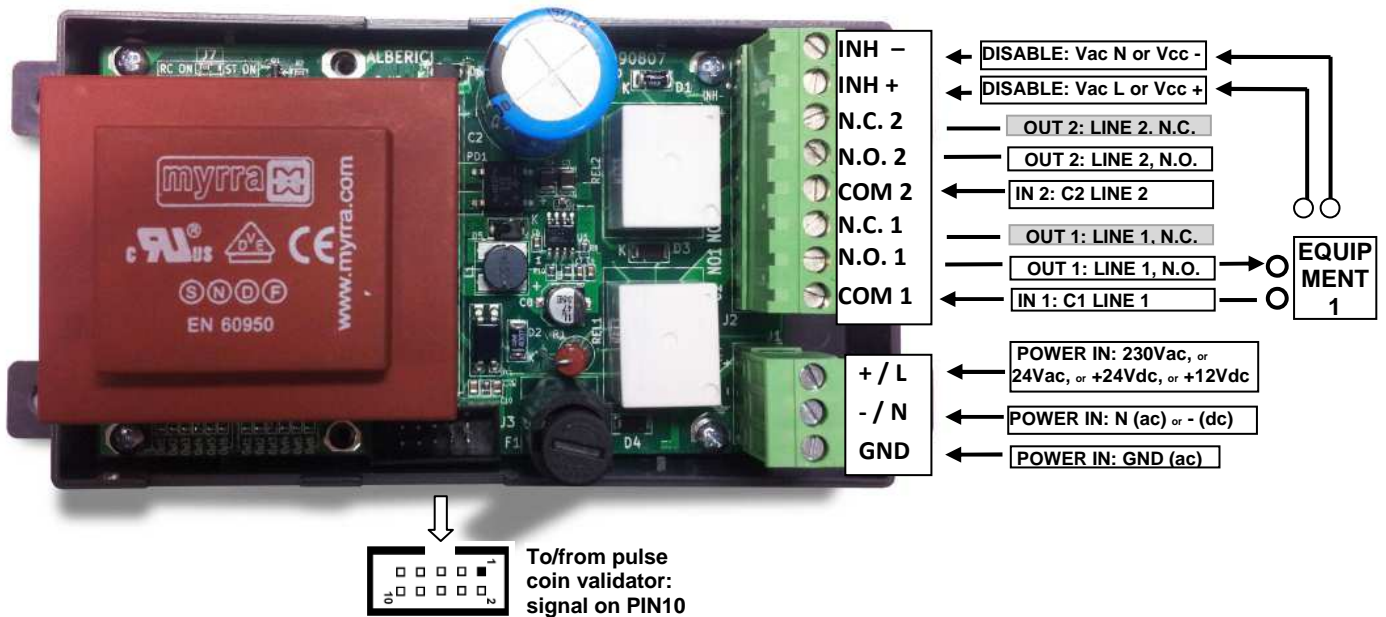

Service line 1 (Pushbutton A): from pin 1 (COM 1) of the J2 connector, take a wire to the actuator of service line 1. If operation mode is “normally open”, take the switching wire to the 1 actuator from pin 2 (N.O. 1). If operation mode must be “normally closed”, take such wire from pin 3 (N.C. 1).

Service line 2 (Pushbutton B): from pin 4 (COM 1) of the J2 connector, take a wire to the actuator of service line 2. If operation mode is “normally open”, take the switching wire to the 2 actuator from pin 5 (N.O. 2). If operation mode must be “normally closed”, take such wire from pin 6 (N.C. 2).

It is possible to disable coin acceptance in any of the following two ways:

- a) Electronically - Pins 7/8 of green connector J2: provide any Vdc (+) or Vac (line value) to pin 7, and respectively 0Vdc (-) or Neutral Vac to pin 8.
- b) Mechanically - move to OFF the dip-switches located on the coin acceptor. Move them back to ON when you want to resume coin acceptance.

5. Operation

5.1 Getting started

Switch the machine on: the display will lit on and will show the following message:

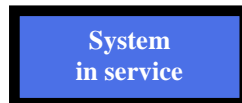

The machine is ready to operate by the following default set values:

Line 1:	price of service = 0,50 € pulse length = 30 sec	Line 2:	price of service = 0,50 € pulse length = 30 sec
----------------	--	----------------	--

The Timebox B is able to simultaneously control two independent pay-for-time service lines, having different price and time length. When introducing one coin, the corresponding credit will be displayed. If such amount is enough to activate at least one of the two service lines, this one (or both of them) shall be proposed, and the relevant pushbutton light will change from blue to green colour.

When pressing the button for service line A (or service line B), the display will briefly show paid amount and total time, then the relevant relay will switch on, and remain on, for the set time. The display will show the progress of the count-down, and the pushbutton will be blinking yellow until end of service time.

If it has been introduced a larger amount than the price for the service, the proportionally larger activation time shall be displayed and activated.

5.2 Modifying the Menu data

5.2.1 Menu configuration

The unit provides a full interactive and user-friendly menu: access it by the button OK, then scroll it by DOWN or UP.

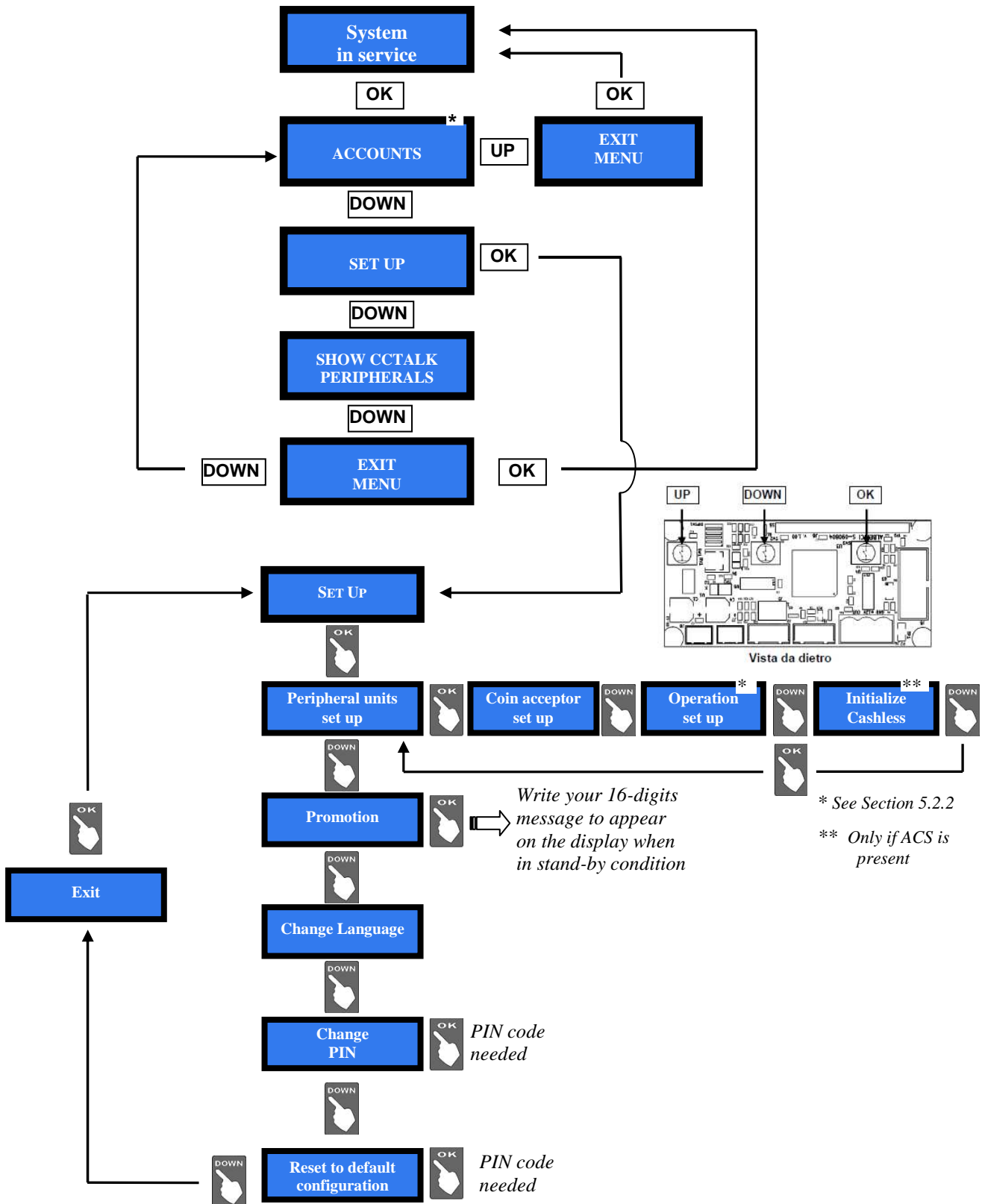

5.2.2 Setting operation parameters

To change price and length of the services, use the buttons behind the board or any of the Management Keys:

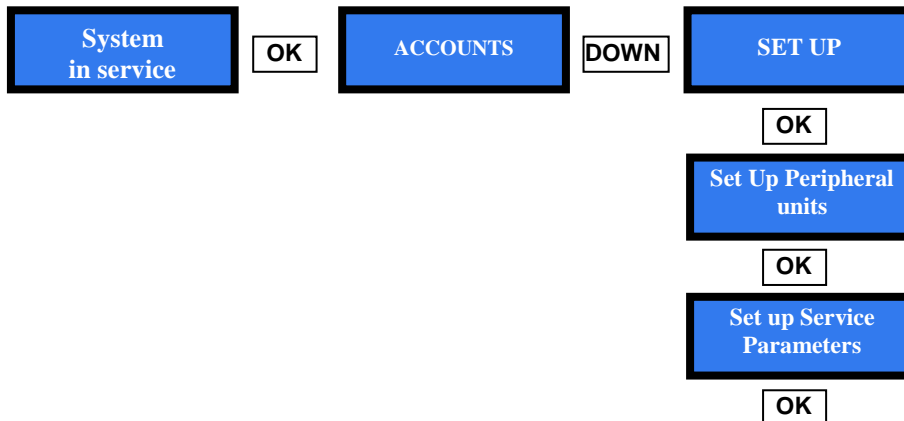

It is now possible to increase the price by the button UP, or decrease it by the button DOWN.

Each stroke changes the value by 0,05 €; pressing for longer than 4 seconds, makes the change run faster.

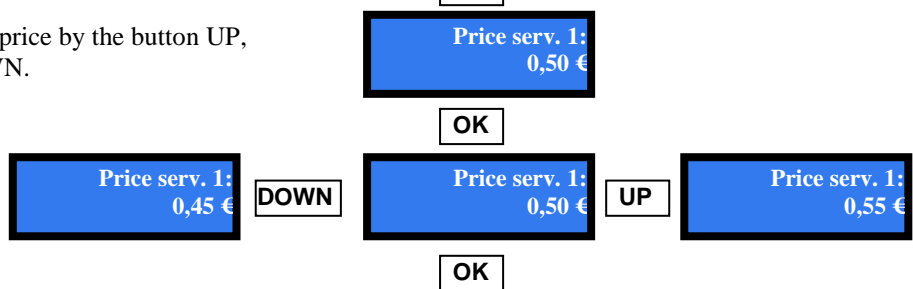

It is now possible to increase the pulse length by the button UP, or decrease it by the button DOWN.

Each stroke changes the value by 0,01 seconda (10 ms); pressing for longer than 4 seconds, makes the change run faster.

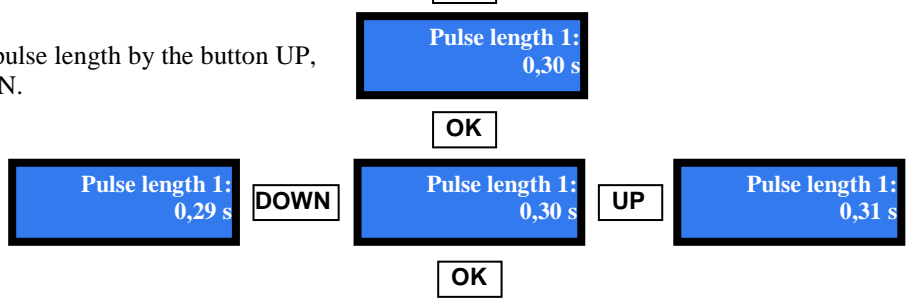

To set the second service line, repeat the above. Or else, press



Press **OK** to display:

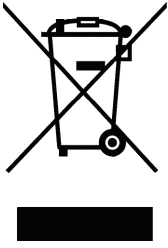

6. Product disposal

	<p style="text-align: center;">WARNING! DISPOSE OF ACCORDING TO THE GOVERNING LAW IN YOUR COUNTRY!</p> <p>This equipment may not be treated as household waste. Instead, it must be handed over to the applicable collection point for the recycling of electric and electronic equipment. By ensuring that this product is dised of correctly, you will help to prevent potential negative consequences for the environment and human health, which could otherwise be caused by inappropriate waste handling of this product.</p> <p>For more detailed information about recycling of this product, please contact the Dealer where you purchased this product.</p>
---	--

7. Terms of Guarantee

The manufacturer will fix malfunctions arising from production faults in this machine or parts of it within 12 months from the date of sale.

All communications referring to guarantee repairs or replacements must be accompanied by the product serial number and the copy of the sale invoice.

To obtain your guarantee repair, please send the part to the Dealer where you purchased the machine, together with the following documents:

- copy of the sale invoice
- delivery note stating "returned for guarantee repair"
- detailed report of the problem found and the circumstances in which it occurs.

Before sending the product, please get in touch with your Dealer or with Alberici S.p.a. (+39 051 944300); very malfunctions can be fixed via a simple phone call, saving you costs and time.

Alberici S.p.a. will verify that warranty is applicable, i.e. that problem is not caused by:

- transport damages
- damages from incorrect installation or wrong configuration
- installation in premises or areas not complying with the prescribed safety requirements
- intentional or unwilling tampering
- wrong or careless use or maintenance
- non-compliance with precautions prescribed (see Chapter 4. Caution)
- natural disasters, vandalisms, intentional or unintentional damage

Guarantee is considered automatically expired if outer and inner labels are missing.

Transport costs of repaired products are at the Customer's charge.

8. Customer Service

Alberici S.p.a. will be pleased to offer all the necessary information on use, ordinary maintenance and technical service. Please call (+39) 051 944300 and specify if your request concerns information on use or technical support.

NOTA

La Alberici S.p.A. si riserva il diritto di apportare modifiche alle specifiche tecniche dell'apparecchiatura descritta in qualunque momento e senza preavviso, nell'ambito del perseguimento del miglioramento continuo del proprio prodotto.



Progettazione e produzione di sistemi di pagamento, accessori per videogames e macchine vending
Design and manufacture of payment systems, accessories for videogames and vending machines

Via Ca' Bianca 421
40024 Castel San Pietro
Terme (BO) – ITALY

Tel. + 39 051 944 300
Fax. + 39 051 944 594

<http://www.alberici.net>

info@alberici.net